



ETA - EUROPEAN TECHNICAL ASSESSMENT

HUS4

Concrete screw

ETA-20/0867 (22.12.2025)



English 2-51

Deutsch 52-101

Public-law institution jointly founded by the federal states and the Federation

European Technical Assessment Body
for construction products



European Technical Assessment

ETA-20/0867
of 22 December 2025

English translation prepared by DIBt - Original version in German language

General Part

Technical Assessment Body issuing the European Technical Assessment:

Deutsches Institut für Bautechnik

Trade name of the construction product

Hilti screw anchor HUS4

Product family
to which the construction product belongs

Mechanical fasteners for use in concrete

Manufacturer

Hilti AG
Feldkircherstraße 100
9494 Schaan
FÜRSTENTUM LIECHTENSTEIN

Manufacturing plant

Hilti Plants

This European Technical Assessment
contains

50 pages including 3 annexes which form an integral part
of this assessment

This European Technical Assessment is
issued in accordance with Regulation (EU)
No 305/2011, on the basis of

EAD 330232-02-0601

This version replaces

ETA-20/0867 issued on 13 June 2025

The European Technical Assessment is issued by the Technical Assessment Body in its official language. Translations of this European Technical Assessment in other languages shall fully correspond to the original issued document and shall be identified as such.

Communication of this European Technical Assessment, including transmission by electronic means, shall be in full. However, partial reproduction may only be made with the written consent of the issuing Technical Assessment Body. Any partial reproduction shall be identified as such.

This European Technical Assessment may be withdrawn by the issuing Technical Assessment Body, in particular pursuant to information by the Commission in accordance with Article 25(3) of Regulation (EU) No 305/2011.

Specific Part

1 Technical description of the product

The Hilti screw anchor HUS4 is an anchor in size 8, 10, 12, 14 and 16 mm made of galvanized and stainless steel. The anchor is screwed into a predrilled cylindrical drill hole. The special thread of the anchor cuts an internal thread into the member while setting. The anchorage is characterised by mechanical interlock in the special thread.

Product and product description are given in Annex A.

2 Specification of the intended use in accordance with the applicable European Assessment Document

The performances given in Section 3 are only valid if the anchor is used in compliance with the specifications and conditions given in Annex B.

The verifications and assessment methods on which this European Technical Assessment is based lead to the assumption of a working life of the anchor of at least 50 years. The indications given on the working life cannot be interpreted as a guarantee given by the producer, but are to be regarded only as a means for choosing the right products in relation to the expected economically reasonable working life of the works.

3 Performance of the product and references to the methods used for its assessment

3.1 Mechanical resistance and stability (BWR 1)

Essential characteristic	Performance
Characteristic resistance to tension load (static and quasi-static loading)	See Annex B5 to B9, Annex C1, C3, C5 and C7
Characteristic resistance to shear load (static and quasi-static loading)	See Annex C2, C4, C6 and C7
Displacements (static and quasi-static loading)	See Annex C21 to C23
Stiffness	No performance assessed
Characteristic resistance and displacements for seismic performance categories C1 and C2	See Annex C8 to C13 and C24

3.2 Safety in case of fire (BWR 2)

Essential characteristic	Performance
Reaction to fire	Class A1
Resistance to fire	See Annex C14 to C20

3.3 Aspects of durability linked with the Basic Works Requirements

Essential characteristic	Performance
Durability	See Annex B1

4 Assessment and verification of constancy of performance (AVCP) system applied, with reference to its legal base

In accordance with European Assessment Document EAD No. 330232-02-0601 the applicable European legal act is: [96/582/EC].

The system to be applied is: 1

5 Technical details necessary for the implementation of the AVCP system, as provided for in the applicable European Assessment Document

Technical details necessary for the implementation of the AVCP system are laid down in the control plan deposited at Deutsches Institut für Bautechnik.

Issued in Berlin on 22 December 2025 by Deutsches Institut für Bautechnik

Dipl.-Ing. Beatrix Wittstock
Head of Section

beglaubigt:
Tempel

Installed condition without adjustment

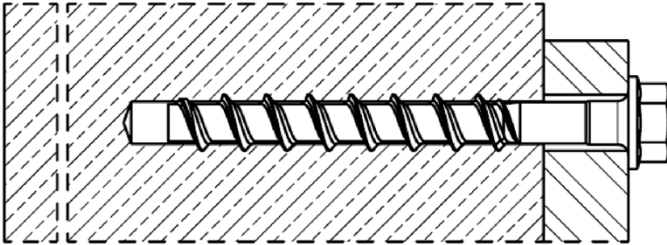

HUS4-H (hexagon head configuration sizes 8, 10, 12, 14 and 16)

HUS4 T-H (hexagon head configuration sizes 8 and 10)

HUS4-HF (hexagon head configuration sizes 8, 10, 12, 14 and 16)

HUS4 T-HF (hexagon head configuration sizes 8 and 10)

HUS4-HR (hexagon head configuration sizes 6, 8, 10 and 14)

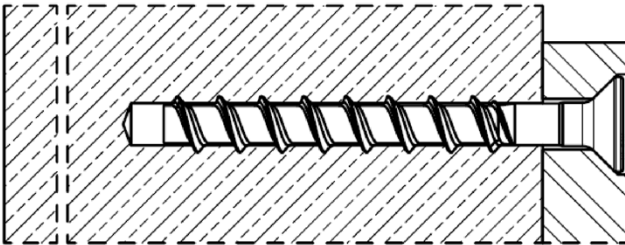

HUS4-C (countersunk head configuration sizes 8 and 10)

HUS4 T-C (countersunk head configuration sizes 8 and 10)

HUS4-CR (countersunk head configuration size 6, 8 and 10)

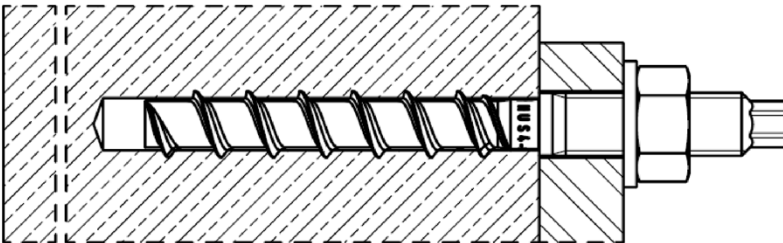

HUS4-A
(threaded rod connection
sizes 10 with M12 and 14 with M16)

HUS4-AF
(threaded rod connection
sizes 10 with M12 and 14 with M16)

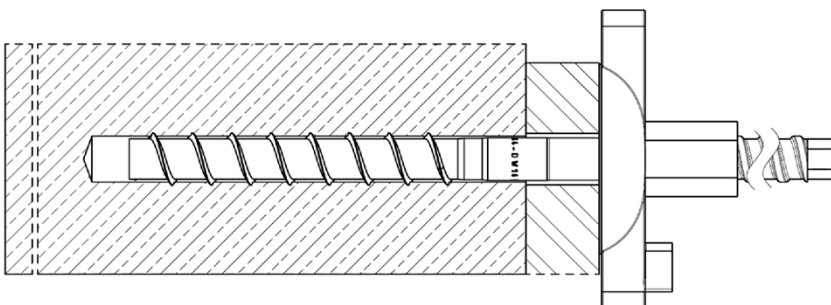

HUS4-DW
(trapezoidal threaded rod connection,
size 16)

Hilti screw anchor HUS4

Product description

Installed condition without adjustment

Annex A1

Installed condition with adjustment

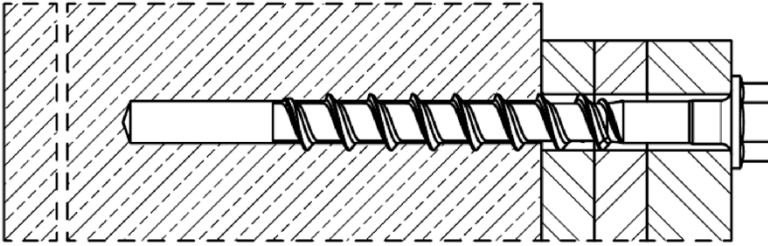

HUS4-H (hexagon head configuration
sizes 8, 10, 12, 14 and 16 G02)

HUS4 T-H (hexagon head configuration
sizes 8 and 10)

HUS4-HF (hexagon head configuration
sizes 8, 10, 12, 14 and 16 G02)

HUS4 T-HF (hexagon head configuration
sizes 8 and 10)

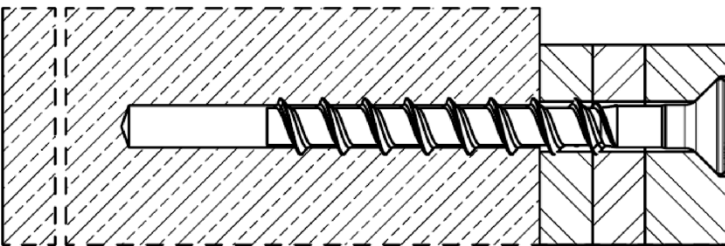

HUS4-C (countersunk head configuration
sizes 8 and 10)

HUS4 T-C (countersunk head
configuration sizes 8 and 10)

Hilti screw anchor HUS4

Product description
Installed condition with adjustment

Annex A2

Table A1: Screw types

Hilti HUS4-H, sizes 8,10, 12, 14 and 16, hexagonal head configuration, carbon steel galvanized
Hilti HUS4-HF, sizes 8,10, 12, 14 and 16, hexagonal head configuration, carbon steel multilayer coating

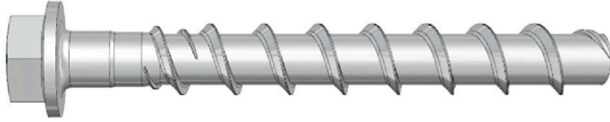

Hilti HUS4 T-H, sizes 8 and 10 hexagonal head configuration, carbon steel galvanized
Hilti HUS4 T-HF, sizes 8 and 10, hexagonal head configuration, carbon steel multilayer coating

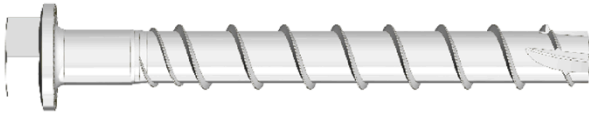

Hilti HUS4-HR, sizes 6, 8, 10 and 14 hexagonal head configuration, stainless steel

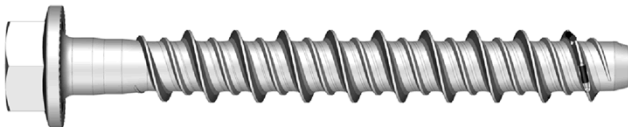

Hilti HUS4-C, sizes 8 and 10, countersunk head configuration, carbon steel galvanized



Hilti HUS4 T-C, sizes 8 and 10, countersunk head configuration, carbon steel galvanized

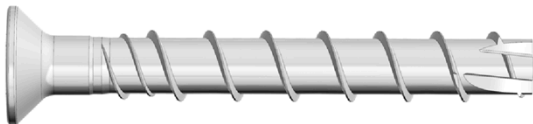

Hilti HUS4-CR, sizes 6, 8 and 10 countersunk head configuration, stainless steel



Hilti HUS4-A, size 10 with external thread M12 and size 14 with external thread M16, carbon steel galvanized
Hilti HUS4-AF, size 10 with external thread M12 and size 14 with external thread M16, carbon steel multilayer coating



Hilti HUS4-DW, size 16 with external trapezoidal thread, carbon steel galvanized



Hilti screw anchor HUS4



Annex A3

Product description
HUS4 screw types

Table A2: Materials

Designation	Material
HUS4 (T)-H(F), HUS4 (T)-C and HUS4-A(F) screw anchor	Carbon steel, galvanized Rupture elongation $A_5 \leq 8\%$
HUS4-HR and HUS4-CR screw anchor	Stainless steel A4 according to EN 10088-1:2014 Rupture elongation $A_5 > 8\%$ Corrosion resistance class CRC III according to EN 1993-1-4:2006+A1:2015
Hilti Filling Set (carbon steel)	Carbon steel, galvanized
Hilti Filling Set A4 (stainless steel)	Stainless steel A4 according to EN 10088-1:2014 Corrosion resistance class CRC III according to EN 1993-1-4:2006+A1:2015
Injection Mortar	Injection Mortar Hilti HIT-HY... or Hilti HIT-RE... (with ETA)

Table A3: Geometry and compatibility of Hilti Filling set

Filling set size		M10	M12	M16	M20
Diameter of filling washer	d_{vs} [mm]	42	44	52	60
Thickness of filling washer	h_{vs} [mm]	5	5	6	6
Thickness of Hilti Filling Set	h_{fs} [mm]	9	10	11	13
Fastener size of HUS4 (T)-H (F, R)		8	10	12 + 14	16
Fastener size of HUS4-A (F)		-	10	14	-

Sealing washer

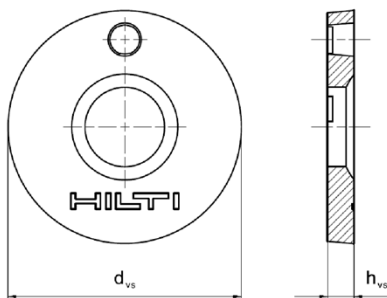

Spherical washer

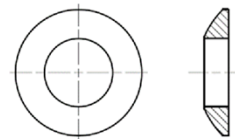

Filling Set

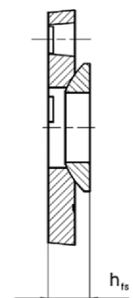



Hilti screw anchor HUS4

Product description
HUS4 Materials

Annex A4

Table A4: Fastener dimensions and marking HUS4-A(F)

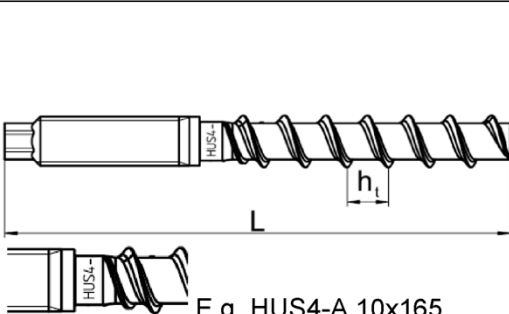
Fastener size HUS4-			A(F) 10			A(F) 14		
Nominal fastener diameter	d	[mm]	10			14		
Metric thread connection			M12			M16		
Pitch of the thread	h_t	[mm]	10			14		
Nominal embedment depth	h_{nom}	[mm]	h_{nom1}	h_{nom2}	h_{nom3}	h_{nom1}	h_{nom2}	h_{nom3}
			55	75	85	65	85	115
Effective embedment depth	h_{ef}	[mm]	$h_{ef} = 0,85 * (h_{nom} - 5) \leq h_{ef,max}$			$h_{ef} = 0,85 * (h_{nom} - 7) \leq h_{ef,max}$		
Limits of effective embedment depth	$h_{ef,max}$	[mm]	68,0			91,8		
Length of screw min / max	L	[mm]	120 / 165			155 / 205		

 <p>E.g. HUS4-A 10x165</p>		HUS4: Hilti Universal Screw 4 th generation					
		A: Thread connection, galvanized					
		AF: Thread connection, multilayer coating					
		10: Nominal screw diameter d [mm]					
		165: Length of screw L [mm]					
		8: Carbon steel					
		K: Length identification HUS4-A 10x165					
G	I	K	J	L	N		
10x120	10x140	10x165	14x155	14x185	14x205		

Hilti screw anchor HUS4

Production description
Fastener dimensions and head marking

Annex A5

Table A5: Fastener dimensions and marking HUS4 (T)-H(F)

Fastener size HUS4-	H(F) 8			T-H(F) 8			H(F) 10			T-H(F) 10		
Nominal fastener diameter d [mm]	8			8			10			10		
Pitch of the thread h _t [mm]	8			8			10			10		
Nominal embedment depth h _{nom} [mm]	h _{nom1}	h _{nom2}	h _{nom3}	h _{nom1}	h _{nom2}	h _{nom3}	h _{nom1}	h _{nom2}	h _{nom3}	h _{nom1}	h _{nom2}	h _{nom3}
	40	60	70	50	60	70	55	75	85	55	75	85
Effective embedment depth h _{ef} [mm]	0,85 * (h _{nom} - 4,0) ≤ h _{ef,max}			0,85 * (h _{nom} - 5,45) ≤ h _{ef,max}			0,85 * (h _{nom} - 5,0) ≤ h _{ef,max}			0,85 * (h _{nom} - 6,1) ≤ h _{ef,max}		
Limits of effective embedment depth h _{ef,max} [mm]	56,1			54,9			68,0			67,1		
Length of screw min / max L [mm]	45 / 150			55 / 150			60 / 305			60 / 150		

Fastener size HUS4-	H(F) 12			H(F) 14			H(F) 16		H(F) 16 G02		
Nominal fastener diameter d [mm]	12			14			16		16		
Pitch of the thread h _t [mm]	12			14			13,2		14,5		
Nominal embedment depth h _{nom} [mm]	h _{nom1}	h _{nom2}	h _{nom3}	h _{nom1}	h _{nom2}	h _{nom3}	h _{nom1}	h _{nom2}	h _{nom1}	h _{nom2}	h _{nom3}
	60	80	100	65	85	115	85	130	85	110	130
Effective embedment depth h _{ef} [mm]	0,85 * (h _{nom} - 6,0) ≤ h _{ef,max}			0,85 * (h _{nom} - 7,0) ≤ h _{ef,max}			0,85 * (h _{nom} - 6,6) ≤ h _{ef,max}		0,85 * (h _{nom} - 7,2) ≤ h _{ef,max}		
Limits of effective embedment depth h _{ef,max} [mm]	79,9			91,8			104,9		104,3		
Length of screw min / max L [mm]	70 / 150			75 / 150			100 / 205		100 / 205		

Hilti screw anchor HUS4

Production description
Fastener dimensions and head marking

Annex A6

Table A6: Fastener dimensions and marking HUS4-HR

Fastener size HUS4-	HR 6	HR 8		HR 10		HR 14		
Nominal fastener diameter d [mm]	6	8		10		14		
Pitch of the thread h _t [mm]	4,75	7,6		8,0		9,8		
Nominal embedment depth h _{nom} [mm]	h _{nom1}	h _{nom1}	h _{nom2}	h _{nom1}	h _{nom2}	h _{nom1}	h _{nom2}	
	55	60	80	70	90	70	110	
Effective embedment depth h _{ef} [mm]	0,85 * (h _{nom} - 2,37) ≤ h _{ef,max}		0,85 * (h _{nom} - 4,8) ≤ h _{ef,max}	0,85 * (h _{nom} - 6,4) ≤ h _{ef,max}		0,85 * (h _{nom} - 9,0) ≤ h _{ef,max}		
Limits of effective embedment depth h _{ef,max} [mm]	45		64	71		86		
Length of screw min / max L [mm]	60 / 70		65 / 105		75 / 130		80 / 135	

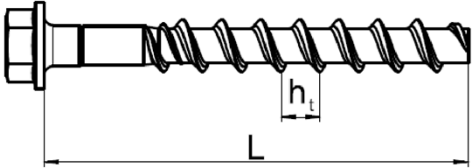
	HUS4: Hilti Universal Screw 4 th generation	
	(T-)H: Hexagonal head, galvanized	
	(T-)HF: Hexagonal head, multilayer coating	
	HR: Hexagonal head, stainless steel	
10:	Nominal screw diameter d [mm]	
100:	Length of screw [mm]	

Hilti screw anchor HUS4

Production description
Fastener dimensions and head marking

Annex A7

Table A7: Fastener dimensions and marking HUS4 (T)-C(R)

Fastener size HUS4-			C 8			T-C 8			C 10			T-C 10		
Nominal fastener diameter	d	[mm]	8			8			10			10		
Pitch of the thread	h_t	[mm]	8			8			10			10		
Nominal embedment depth	h_{nom}	[mm]	h_{nom1}	h_{nom2}	h_{nom3}	h_{nom1}	h_{nom2}	h_{nom3}	h_{nom1}	h_{nom2}	h_{nom3}	h_{nom1}	h_{nom2}	h_{nom3}
			40	60	70	50	60	70	55	75	85	55	75	85
Effective embedment depth	h_{ef}	[mm]	$0,85 * (h_{nom} - 4) \leq h_{ef,max}$			$0,85 * (h_{nom} - 5,45) \leq h_{ef,max}$			$0,85 * (h_{nom} - 5) \leq h_{ef,max}$			$0,85 * (h_{nom} - 6,1) \leq h_{ef,max}$		
Limits of effective embedment depth	$h_{ef,max}$	[mm]	56,1			54,9			68,0			67,1		
Length of screw min / max	L	[mm]	55 / 160			65 / 85			70 / 180			70 / 305		

Fastener size HUS4-			CR 6		CR 8		CR 10	
Nominal fastener diameter	d	[mm]	6		8		10	
Pitch of the thread	h_t	[mm]	4,75		7,6		8,0	
Nominal embedment depth	h_{nom}	[mm]	h_{nom2}		h_{nom2}	h_{nom3}	h_{nom2}	h_{nom3}
			55		60	80	70	90
Effective embedment depth	h_{ef}	[mm]	$0,85 * (h_{nom} - 2,37) \leq h_{ef,max}$		$0,85 * (h_{nom} - 4,8) \leq h_{ef,max}$		$0,85 * (h_{nom} - 6,4) \leq h_{ef,max}$	
Limits of effective embedment depth	$h_{ef,max}$	[mm]	45		64		71	
Length of screw min / max	L	[mm]	60 / 70		65 / 95		75 / 105	

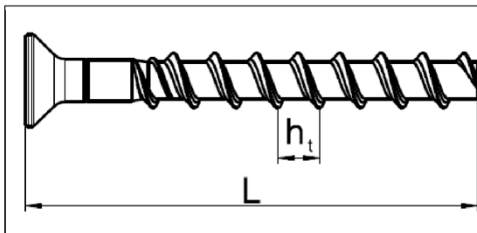

HUS4: Hilti Universal Screw 4th generation
(T-)C: Countersunk head, galvanized
CR: Countersunk head, stainless steel
10: Nominal screw diameter d [mm]
100: Length of screw L [mm]

Hilti screw anchor HUS4

Production description
Fastener dimensions and head marking

Annex A8

Table A8: Fastener dimensions and marking HUS4-DW

Fastener size HUS4-			DW 16
Nominal fastener diameter	d	[mm]	16
Pitch of the thread	h_t	[mm]	14,5
Nominal embedment depth	h_{nom}	[mm]	h_{nom}
			130
Effective embedment depth	h_{ef}	[mm]	$0,85 * (h_{nom} - 7,2) \leq h_{ef,max}$
Limits of effective embedment depth	$h_{ef,max}$	[mm]	104,3
Length of screw min / max	L	[mm]	458 / 858

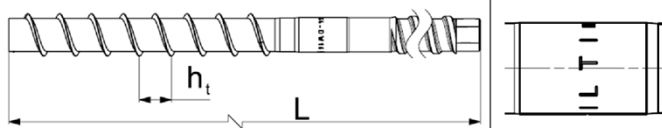
	HUS4: Hilti Universal Screw 4 th generation
	DW: trapezoidal thread connection, galvanized
	16: Nominal screw diameter d [mm]
	458: Length of screw [mm]

Hilti screw anchor HUS4

Production description
Fastener dimensions and head marking

Annex A9

Specifications of intended use

Anchorage subject to:

- Static and quasi-static loadings
- Seismic action for performance category C1 and C2 for HUS4 (T)-H(F)/-C/-A(F) (carbon steel screw)
- Seismic action for performance category C1: HUS4-HR/-CR (stainless steel screw)
- Fire exposure

Base materials:

- Compacted reinforced or unreinforced normal weight concrete according to EN 206:2013 +A1:2016.
- Strength classes C20/25 to C50/60 according to EN 206-1:2010+A1:2016.
- Cracked and uncracked concrete.
- The fastener is intended to be used in fibre reinforced concrete according to EN 206:2013 +A2:2021 including steel fibres (SFRC) according to EN 14889-1:2006 clause 1, group I. The maximum content of steel fibres is 80 kg/m³.

Use conditions (Environmental conditions):

- Anchorages subject to dry internal conditions: all screw types
- For all other conditions corresponding to corrosion resistance classes CRC according to EN 1993-1-4:2006+A1:2015
 - Stainless steel according to Annex A3 Table A2, screw types HUS4-HR/-CR: CRC III

Design:

- Anchorages are designed under the responsibility of an engineer experienced in anchorages and concrete work.
- Verifiable calculation notes and drawings are prepared taking account of the loads to be anchored. The position of the fastener is indicated on the design drawings (e. g. position of the fastener relative to reinforcement or to supports, etc.).
- Anchorages are designed in accordance with: EN 1992-4:2018 and EOTA Technical Report TR 055, edition February 2018.
- In case of requirements to resistance to fire local spalling of the concrete cover must be avoided.
- The design method according to EN 1992-4:2018 applies for use in Steel Fibre Reinforced Concrete (SFRC) with the essential characteristics as specified for plain concrete without fibres.

Installation:

- Fastener installation carried out by appropriately qualified personnel and under the supervision of the person responsible for technical matters on site.
- In case of aborted hole: new drilling at a minimum distance away of twice the depth of the aborted hole or smaller distance if the aborted hole is filled with high strength mortar and if under shear or oblique tension load it is not the direction of the load application.
- After installation further turning of the fastener must not be possible.
- The head of the fastener (HUS4 (T)-H (F, R) and HUS4 (T)-C/-CR) must be supported on the fixture and is not damaged.
- Hilti filling set is suitable for HUS4 (T)-H (F, R) and HUS4-A (F)

Hilti screw anchor HUS4	Annex B1
Intended use Specifications	

Specifications of intended use: Drilling and cleaning for HUS4 carbon steel

Adjustment according to Annex B11 is possible for carbon steel HUS4 screws in sizes 8 to 10 at h_{nom2+3} and 12, 14 and 16 G02 at all h_{nom} .

Table B1: HUS4 (T)-H(F)/-C/-A(F) intended use for static and quasi static loading



HUS4 (T)-H(F)/-C/-A(F) carbon steel		Fastener size and embedment depth h_{nom}
Cracked and uncracked concrete		
Hammer drilling (HD) ¹⁾	cleaned	sizes 8 to 16 at all h_{nom}
	not cleaned 	sizes 8 to 14 and 16 G02 at all h_{nom}
Hammer drilling with Hilti hollow drill bit TE-CD (HDB) ¹⁾		sizes 12 and 14 at all h_{nom}
Uncracked concrete		
Diamond coring (DD) DD30-W handheld and with stand DD-EC1 handheld		sizes 10 to 14 at h_{nom3} (HUS4 T excluded)

Table B2: HUS4 (T)-H(F)/-C/-A(F) intended use for seismic performance category C1



HUS4 (T)-H(F)/-C/-A(F) carbon steel		Fastener size and embedment depth h_{nom}
Hammer drilling (HD) ¹⁾	cleaned	sizes 8 to 16 at all h_{nom} (HUS4 8 at h_{nom1} excluded)
	not cleaned 	sizes 8 to 14, 16 G02 and 16 DW at all h_{nom} (HUS4 8 at h_{nom1} excluded)
Hammer drilling with Hilti hollow drill bit TE-CD (HDB) ¹⁾		sizes 12 and 14 at all h_{nom}

Table B3: HUS4 (T)-H(F)/-C/-A(F) intended use for seismic performance category C2



HUS4 (T)-H(F)/-C/-A(F) carbon steel		Fastener size and embedment depth h_{nom}
Hammer drilling (HD) ¹⁾	Cleaned and not cleaned 	sizes 8 to 14, 16 G02 and 16 DW at all h_{nom} (HUS4 8 at h_{nom1} excluded)

Table B4: HUS4 (T)-H(F)/-C/-A(F) intended use for static and quasi static loading under fire exposure



HUS4 (T)-H(F)/-C/-A(F) carbon steel		Fastener size and embedment depth h_{nom}
Hammer drilling (HD) ¹⁾	cleaned	sizes 8 to 16 at all h_{nom}
	not cleaned 	sizes 8 to 14 and 16 G02 at all h_{nom}
Hammer drilling with Hilti hollow drill bit TE-CD (HDB) ¹⁾		sizes 12 and 14 at all h_{nom}

Hilti screw anchor HUS4

Intended use
Specifications

Annex B2

Table B5: Intended use for HUS4 (T)-H(F)-C/-A(F) in concrete with SFRC (seismic category C2 is excluded)

HUS4 (T)-H(F)-C/-A(F) carbon steel		Fastener size and embedment depth h_{nom}
Cracked and uncracked concrete		
Hammer drilling (HD) ¹⁾	cleaned	sizes 8 to 16 at all h_{nom}
	not cleaned	sizes 8 to 14 and 16 G02 at all h_{nom}
Hammer drilling with Hilti hollow drill bit TE-CD (HDB) ¹⁾		sizes 12 and 14 at all h_{nom}
Uncracked concrete		
Diamond coring (DD) DD30-W handheld and with stand DD-EC1 handheld		sizes 10 to 14 at h_{nom3} (HUS4 T excluded)

Specifications of intended use: Drilling and cleaning for HUS4 stainless steel

Adjustment according to Annex B11 is not possible.

Table B6: HUS4-HR/-CR intended use for static and quasi static loading

HUS4-HR/-CR stainless steel		Fastener size and embedment depth h_{nom}
Cracked and uncracked concrete		
Hammer drilling (HD)	cleaned	sizes 6 to 14 at all h_{nom}
	not cleaned	

Table B7: HUS4-HR/-CR intended use for seismic performance category C1

HUS4-HR/-CR stainless steel		Fastener size and embedment depth h_{nom}
Hammer drilling (HD)	cleaned	sizes 8 to 14 at h_{nom2}
	not cleaned	sizes 8 to 14 at h_{nom2}

Table B8: HUS4-HR/-CR intended use for static and quasi static loading under fire exposure

HUS4-HR/-CR stainless steel		Fastener size and embedment depth h_{nom}
Hammer drilling (HD)	cleaned	sizes 6 to 14 at all h_{nom}
	not cleaned	sizes 6 to 14 at all h_{nom}

Hilti screw anchor HUS4

Annex B3

Intended use
Specifications

Installation parameters

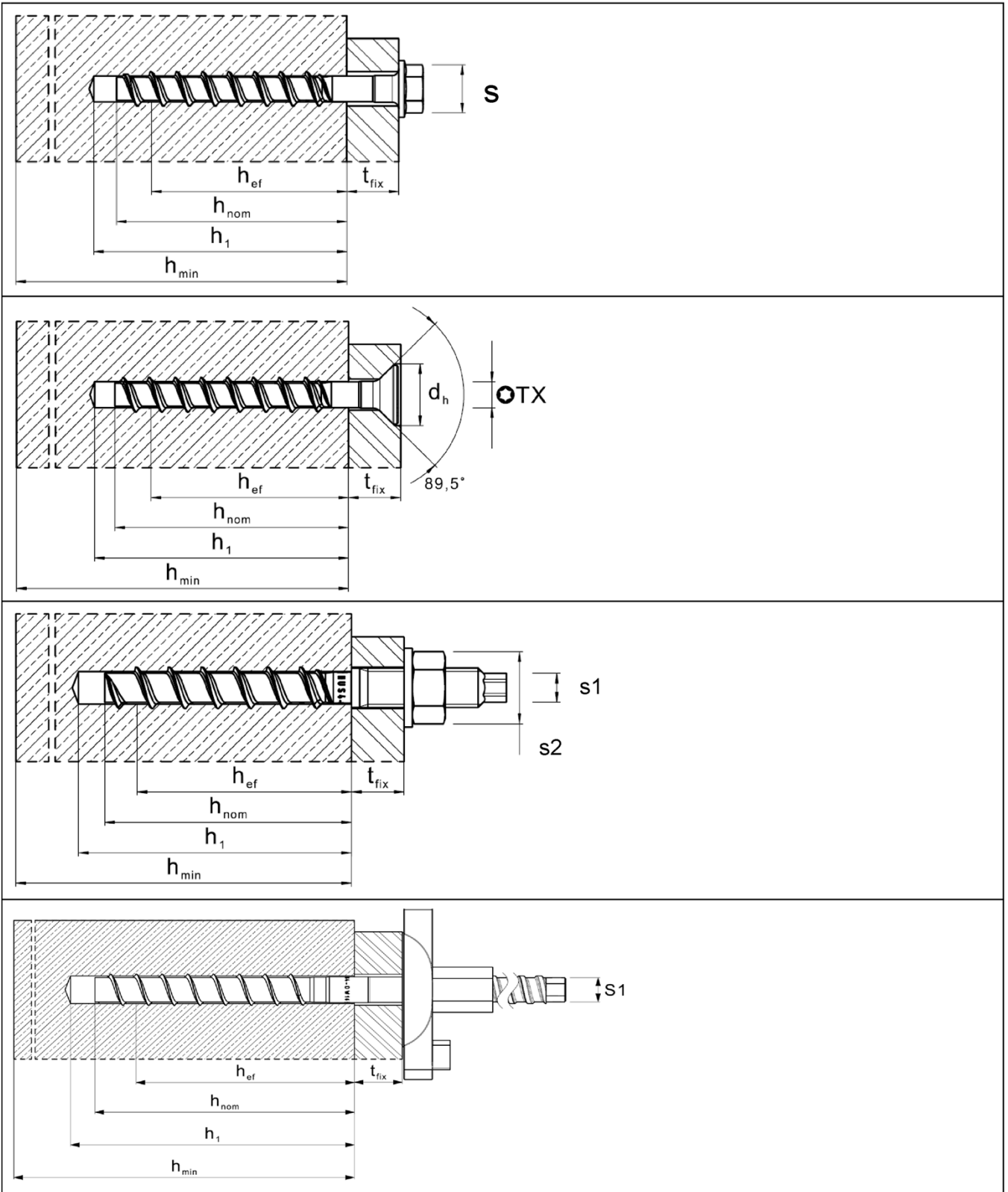

Hilti screw anchor HUS4

Intended use
Installation parameters

Annex B4

Table B9: Installation parameters HUS4 8 and 10

Fastener size HUS4 Type			8 H(F), C			8 T-H(F), T-C			10 H(F), C, A(F)		
			h_{nom1}	h_{nom2}	h_{nom3}	h_{nom1}	h_{nom2}	h_{nom3}	h_{nom1}	h_{nom2}	h_{nom3}
Nominal embedment depth	h_{nom}	[mm]	40	60	70	50	60	70	55	75	85
Nominal drill hole diameter	d_0	[mm]	8			8			10		
Cutting diameter of drill bit	$d_{cut} \leq$	[mm]	8,45			8,45			10,45		
Cutting diameter of diamond core bit	$d_{cut} \leq$	[mm]	-			-			9,9		
Clearance hole diameter through setting	$d_f \frac{\min}{\max}$	[mm]	11			11			13		
			12			12			14		
Clearance hole diameter pre setting (A-type)	$d_f \leq$	[mm]	-			-			14		
Wrench size (H, HF-type)	s	[mm]	13			13			15		
Wrench size for hex head (A-type)	s1	[mm]	-			-			8		
Wrench size for nut (A-type)	s2	[mm]	-			-			19		
Maximum installation torque (A-type)	$\max T_{inst}$	[Nm]	-			-			40		
Torx size (C-type)	TX	-	45			45			50		
Diameter of countersunk head	d_h	[mm]	18			18			21		
Depth of drill hole for cleaned hole hammer drilling, diamond coring or for uncleaned hole when drilling upwards	$h_1 \geq$	[mm]	(h _{nom} + 10 mm)								
			50	70	80	60	70	80	65	85	95
Depth of drill hole for uncleaned hole hammer drilling in wall and floor position	$h_1 \geq$	[mm]	h _{nom} + 25						h _{nom} + 30		
			65	85	95	75	85	95	85	105	115
Depth of drill hole (with adjustability) for cleaned hole hammer drilling, diamond coring or for uncleaned hole when drilling upwards	$h_1 \geq$	[mm]	h _{nom} + 20 mm								
			-	80	90	70	80	90	-	95	105
Depth of drill hole (with adjustability) for uncleaned hole hammer drilling in wall and floor position	$h_1 \geq$	[mm]	h _{nom} + 35						h _{nom} + 40		
			-	95	105	85	95	105	-	115	125
Minimum thickness of concrete member	$h_{min} \geq$	[mm]	h ₁ + 30 mm								
			80	100	120	100	100	120	100	130	140
Minimum spacing	$s_{min} \geq$	[mm]	35			50 ²⁾	50	50	40		
Minimum edge distance	$c_{min} \geq$	[mm]	35			40	40	40	40		
Hilti Setting tool ¹⁾			SIW 4(AT)-22 SIW 6(AT)-A22 SIW 6(AT)-22 gear 1 SI-AT-22 module optional						SIW 6(AT)-22 SIW 22T-A SIW 8-22 gear 1 SIW 9-A22 SI-AT-22 module optional		

¹⁾ Installation with other impact wrench of equivalent power is possible.

²⁾ $s_{min} = 40$ mm is possible if $c_{min} \geq 50$ mm.

Hilti screw anchor HUS4

Intended use
Installation parameters

Annex B5

Table B10: Installation parameters HUS4 10 to 14

Fastener size HUS4 Type			10			12			14		
			T-H(F), T-C			H(F)			H(F), A(F)		
			h_{nom1}	h_{nom2}	h_{nom3}	h_{nom1}	h_{nom2}	h_{nom3}	h_{nom1}	h_{nom2}	h_{nom3}
Nominal embedment depth	h_{nom}	[mm]	55	75	85	60	80	100	65	85	115
Nominal drill hole diameter	d_0	[mm]	10			12			14		
Cutting diameter of drill bit	$d_{cut} \leq$	[mm]	10,45			12,50			14,50		
Cutting diameter of diamond core bit	$d_{cut} \leq$	[mm]	-			12,2			14,2		
Clearance hole diameter through setting	$d_f \frac{\min}{\max}$	[mm]	14			16			18		
Clearance hole diameter pre setting (A-type)	$d_f \leq$	[mm]	-			-			18		
Wrench size (H, HF-type)	s	[mm]	15			17			21		
Wrench size for hex head (A-type)	s1	[mm]	-			-			12		
Wrench size for nut (A-type)	s2	[mm]	-			-			24		
Maximum installation torque (A-type)	$\max T_{inst}$	[Nm]	-			-			80		
Torx size (C-type)	TX	-	50			-			-		
Diameter of countersunk head	d_h	[mm]	21			-			-		
Depth of drill hole for cleaned hole hammer drilling, diamond coring or for uncleaned hole when drilling upwards	$h_1 \geq$	[mm]	$h_{nom} + 10 \text{ mm}$								
			65	85	95	70	90	110	75	95	125
Depth of drill hole for uncleaned hole hammer drilling in wall and floor position	$h_1 \geq$	[mm]	$h_{nom} + 30$			$h_{nom} + 35$			$h_{nom} + 40$		
			85	105	115	95	115	135	105	125	155
Depth of drill hole (with adjustability) for cleaned hole hammer drilling, diamond coring or for uncleaned hole when drilling upwards	$h_1 \geq$	[mm]	$h_{nom} + 20 \text{ mm}$								
			75	95	105	80	100	120	85	105	135
Depth of drill hole (with adjustability) for uncleaned hole hammer drilling in wall and floor position	$h_1 \geq$	[mm]	$h_{nom} + 40$			$h_{nom} + 45$			$h_{nom} + 50$		
			95	115	125	105	125	145	115	135	165
Minimum thickness of concrete member	$h_{min} \geq$	[mm]	$h_1 + 30 \text{ mm}$								
			100	130	140	110	130	150	120	160	200
Minimum spacing	$s_{min} \geq$	[mm]	50			50			60		
Minimum edge distance	$c_{min} \geq$	[mm]	50			50			60		
Hilti Setting tool ¹⁾			SIW 6(AT)-22 SIW 22T-A SIW 8-22 gear 1 SIW 9-A22 SI-AT-22 module optional			SIW 6(AT)-22 SIW 22T-A SIW 8-22 SIW 9-A22 SI-AT-22 module optional					

¹⁾ Installation with other impact wrench of equivalent power is possible.

Hilti screw anchor HUS4

Intended use
Installation parameters

Annex B6

Table B11: Installation parameters HUS4-16

Fastener size HUS4			16		16			16
Type			H(F)		H(F) G02			DW
			h_{nom1}	h_{nom2}	h_{nom1}	h_{nom2}	h_{nom3}	h_{nom}
Nominal embedment depth	h_{nom}	[mm]	85	130	85	110	130	130
Nominal drill hole diameter	d_0	[mm]	16		16			16
Cutting diameter of drill bit	$d_{cut} \leq$	[mm]	16,50		16,50			16,50
Clearance hole diameter through setting	$d_f \leq$	[mm]	20		20			20
Clearance hole diameter pre setting (DW-type)	$d_f \leq$	[mm]	-		-			20
Wrench size (H, HF-type)	s	[mm]	24		24			-
Wrench size for hex head (DW-type)	s1	[mm]	-		-			13
Depth of drill hole for cleaned hole hammer drilling or for uncleaned hole when drilling upwards	$h_1 \geq$	[mm]	$h_{nom} + 10 \text{ mm}$					
			95	140	95	120	140	140
Depth of drill hole for uncleaned hole hammer drilling in wall and floor position	$h_1 \geq$	[mm]	-		$h_{nom} + 40 \text{ mm}$			
					125	150	170	170
Depth of drill hole (with adjustability) for cleaned hole hammer drilling, diamond coring or for uncleaned hole when drilling upwards	$h_1 \geq$	[mm]	-		$h_{nom} + 20 \text{ mm}$			
					105	130	150	150
Depth of drill hole (with adjustability) for uncleaned hole hammer drilling in wall and floor position	$h_1 \geq$	[mm]	-		$h_{nom} + 50 \text{ mm}$			
					135	160	180	180
Minimum thickness of concrete member	$h_{min} \geq$	[mm]	$h_1 + 35 \text{ mm}$					
			130	195	130	155	175	175
Minimum spacing	$s_{min} \geq$	[mm]	90		70			
Minimum edge distance	$c_{min} \geq$	[mm]	65		65			
Hilti Setting tool ¹⁾			SIW 22T-A SIW 6(AT)-22 SIW 8-22 SIW 9-A22 SIW 10-22 SI-AT-22 module optional					SIW 22T-A SIW 6(AT)-22 SIW 8-22 SIW 9-A22 SIW 10-22

¹⁾ Installation with other impact wrench of equivalent power is possible.

Hilti screw anchor HUS4

Intended use
Installation parameters

Annex B7

Table B12: Installation parameters HUS4-HR/-CR 6 and 8

Fastener size HUS4			6	8	
Type			HR, CR	HR, CR	
			h_{nom1}	h_{nom1}	h_{nom2}
Nominal embedment depth	h_{nom}	[mm]	55	60	80
Nominal drill hole diameter	d_0	[mm]	6	8	
Cutting diameter of drill bit	$d_{cut} \leq$	[mm]	6,40	8,45	
Clearance hole diameter	$d_f \leq$	[mm]	9	12	
Wrench size (H-type)	s	[mm]	13	13	
Torx size (C-type)	TX	[-]	30	45	
Diameter of countersunk head	d_h	[mm]	11	18	
Depth of drill hole for cleaned hole hammer drilling or for uncleaned hole when drilling upwards	$h_1 \geq$	[mm]	$h_{nom} + 10 \text{ mm}$		
			65	70	90
Depth of drill hole for uncleaned hole hammer drilling in wall and floor position	$h_1 \geq$	[mm]	$h_{nom} + 20 \text{ mm}$		$h_{nom} + 25 \text{ mm}$
			75	85	105
Minimum thickness of concrete member	$h_{min} \geq$	[mm]	$h_1 + 30 \text{ mm}$		
			100	100	120
Minimum spacing	$s_{min} \geq$	[mm]	35	45	50
Minimum edge distance	$c_{min} \geq$	[mm]	35	45	50
Hilti Setting tool ¹⁾			SIW 6(AT)-A22 SIW 4(AT)-22 SI-AT-22 module optional	SIW 22T-A SIW 6(AT)-A22 SIW 4(AT)-22 SIW 6(AT)-22 SI-AT-22 module optional	

¹⁾ Installation with other impact wrench of equivalent power is possible.

Hilti screw anchor HUS4

Intended use
Installation parameters

Annex B8

Table B13: Installation parameters HUS4-HR/-CR 10 and 14

Fastener size HUS4 Type			10		14	
			HR, CR		HR	
			h_{nom1}	h_{nom2}	h_{nom1}	h_{nom2}
Nominal embedment depth	h_{nom}	[mm]	70	90	70	110
Nominal drill hole diameter	d_0	[mm]	10		14	
Cutting diameter of drill bit	$d_{cut} \leq$	[mm]	10,45		14,50	
Clearance hole diameter	$d_f \leq$	[mm]	14		18	
Wrench size (H-type)	s	[mm]	15		21	
Torx size (C-type)	TX	[-]	50		-	
Diameter of countersunk head	d_h	[mm]	21		-	
Depth of drill hole for cleaned hole hammer drilling, diamond coring or for uncleaned hole when drilling upwards	$h_1 \geq$	[mm]	$h_{nom} + 10\text{mm}$			
			80	100	80	120
Depth of drill hole for uncleaned hole hammer drilling in wall and floor position	$h_1 \geq$	[mm]	$h_{nom} + 30\text{ mm}$		$h_{nom} + 40\text{ mm}$	
			100	120	110	150
Minimum thickness of concrete member	$h_{min} \geq$	[mm]	$h_1 + 30\text{ mm}$			
			120	140	140	160
Minimum spacing	$s_{min} \geq$	[mm]	50		50	60
Minimum edge distance	$c_{min} \geq$	[mm]	50		50	60
Hilti Setting tool ¹⁾			SIW 22T-A SIW 6(AT)-A22 SIW 4(AT)- 22 SIW 6(AT)-22 SI-AT-22 module optional		SIW 22T-A SIW 6(AT)-22 SIW 8-22 gear 1 SIW 9-A22 SI-AT-22 module optional	

¹⁾ Installation with other impact wrench of equivalent power is possible.

Hilti screw anchor HUS4

Intended use
Installation parameters

Annex B9

Installation instructions

Hole drilling and cleaning

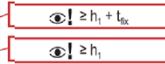
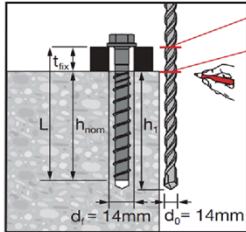

Select the right drill bit size
Mark drilling depth h_1 for pre or through installation.
Details for drilling depth h_1 for the different drilling methods (with and without cleaning) and directions in table B9 to B13.

Hammer drilling (HD)

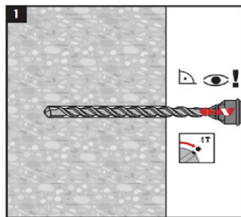

Hammer drilling (HD):

- All sizes for carbon and stainless steel

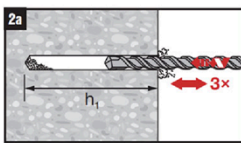

No cleaning is allowed when:

- drilling in upward direction
- drilling in downward and horizontal direction when 3x ventilation¹⁾ after drilling is executed.
- h_1 according B9 to B13 for uncleaned hole
¹⁾ moving the drill bit in and out of the drill hole 3 times after the recommended drilling depth h_1 is achieved. This procedure shall be done with both revolution and hammer functions activated in the drilling machine. For more details read the relevant installation instruction (MPII).

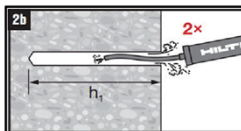

Cleaning is needed:

- When drilling in downward and horizontal direction
- For HUS4 16 (not for 16 G02)

Hammer drilling with Hilti hollow drill bit (HDB)

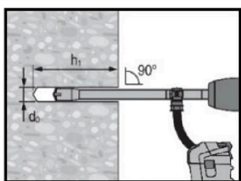

Hammer drilling with Hilti hollow drill bit (HDB):

- Size 12 and 14 for carbon steel screw
- No cleaning needed

Diamond coring (DD)

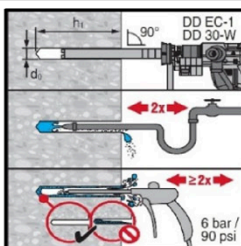

Diamond coring (DD):

- Size 10 to 14 for carbon steel screw
- Cleaning needed in all installation directions

Hilti screw anchor HUS4

Intended use
Installation instructions

Annex B10

Fastener setting

SIW 6AT-A22 1/2", SIW 4AT-22 1/2"	❌
SIW 6-22 1/2"	✅
SIW 22T-A 1/2", SIW 22T-A 3/4"	✅
SIW 9-A22 3/4"	✅
SIW 8-22 1/2"	✅
SIW 10-22 3/4"	✅

Select the right impact wrench for the used screw (see Table B9 to B13)



Optional: insert the SI-AT-22 module between the battery and the tool and select the anchor or scan the anchor box (in the case the gear is automatically selected)

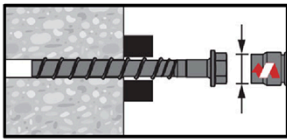

Installation using an impact wrench.
In case SI-AT-22 module is used, no gear selection on the tool needed.

Optional: Adjusting process (carbon steel screws only)

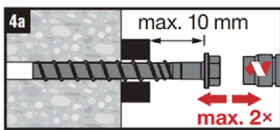

Unscrew by a maximum of 10 mm. A screw may be adjusted up to two times. The total thickness of shims added during the adjustment process must not exceed 10 mm.

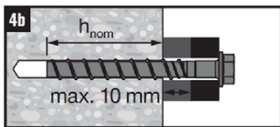

The final embedment depth after adjustment process must be larger or equal than the required one (e.g. h_{nom1} , h_{nom2} or h_{nom3}).

Setting check

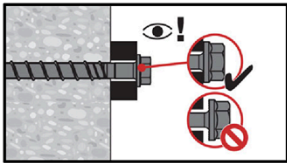

The screw head must be in contact with the fixture

Optional: Fastener setting with Hilti filling set

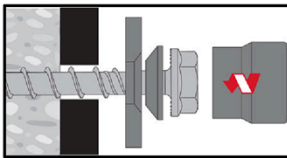

Setting with Hilti filling set

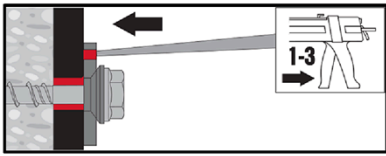

Fill the annular gap between screw and fixture with 1-3 strokes of a Hilti injection mortar HIT-HY ... or HIT-RE
Follow the installation instructions supplied with the respective Hilti injection mortar. After required curing time t_{cure} the fastening can be loaded.

Hilti screw anchor HUS4

Intended use
Installation instructions

Annex B11

Table C1: Essential characteristics under static and quasi-static load in concrete for HUS4 carbon steel size 8 and 10

Fastener size HUS4			8			8			10		
Type			H(F), C			T-H(F), T-C			H(F), C, A(F)		
Nominal embedment depth	h_{nom}	[mm]	h_{nom1}	h_{nom2}	h_{nom3}	h_{nom1}	h_{nom2}	h_{nom3}	h_{nom1}	h_{nom2}	h_{nom3}
			40	60	70	50	60	70	55	75	85
Adjustment											
Total max. thickness of adjustment layers	t_{adj}	[mm]	-	10	10	-	10	10	-	10	10
Max. number of adjustments	n_{adj}	[-]	-	2	2	-	2	2	-	2	2
Steel failure for tension load											
Characteristic resistance	$N_{Rk,s}$	[kN]	36,0			39,2			55,0		
Partial factor	$\gamma_{Ms,N}^{1)}$	[-]	1,5			1,4			1,5		
Pull-out failure											
Characteristic resistance in uncracked concrete C20/25	$N_{Rk,p,ucr}$	[kN]	$\geq N_{Rk,c}^{0,3)}$			9	12	16	13	22	$\geq N_{Rk,c}^{0,3)}$
Characteristic resistance in cracked concrete C20/25	$N_{Rk,p,cr}$	[kN]	5,5	$\geq N_{Rk,c}^{0,3)}$		6	9	12	$\geq N_{Rk,c}^{0,3)}$		
Increasing factor for $N_{Rk,p} = N_{Rk,p(C20/25)} * \psi_c$	ψ_c	[-]	$(f_{ck}/20)^{0,5}$								
Concrete cone and splitting failure											
Effective embedment depth	$h_{ef}^{2)}$	[mm]	30,6	47,6	56,1	40	46,4	54,9	42,5	59,5	68,0
Factor for	Uncracked	$k_{ucr,N}$	11,0								
	Cracked	$k_{cr,N}$	7,7								
Concrete cone failure	Edge distance	$c_{cr,N}$	1,5 h_{ef}								
	Spacing	$s_{cr,N}$	3 h_{ef}								
Characteristic resistance	$N_{Rk,sp}^0$	[kN]	$\min(N_{Rk,p}; N_{Rk,c}^{0,2),3)}$								
Splitting failure	Edge distance	$c_{cr,sp}$	1,5 h_{ef}			1,5 h_{ef}			1,65 h_{ef}		
	Spacing	$s_{cr,sp}$	3,0 h_{ef}			3,0 h_{ef}			3,30 h_{ef}		
Installation factor	γ_{inst}	[-]	1,0						1,2	1,0	

1) In absence of other national regulations.

2) In case $h_{nom} > h_{nom1}$ and $< h_{nom3}$ the actual h_{ef} for concrete failure can be calculated according to Tables A4, A5 or A7

3) $N_{Rk,c}^0$ for C20/25 according to EN 1992-4:2018

Hilti screw anchor HUS4

Performances
Essential characteristics under static and quasi-static load in concrete

Annex C1

Table C1 continued

Fastener size HUS4 Type			8 H(F), C			8 T-H(F), T-C			10 H(F), C, A(F)		
			h_{nom1}	h_{nom2}	h_{nom3}	h_{nom1}	h_{nom2}	h_{nom3}	h_{nom1}	h_{nom2}	h_{nom3}
Nominal embedment depth	h_{nom}	[mm]	40	60	70	50	60	70	55	75	85
Steel failure for shear load											
Characteristic resistance	$V^0_{Rk,s}$	[kN]	18,8	21,9		19,0	22,0		28,8	32,0	
Partial factor	$\gamma_{Ms,V}^{1)}$	[-]	1,25			1,50			1,25		
Ductility factor	k_7	[-]				0,8					
Characteristic resistance	$M^0_{Rk,s}$	[Nm]	32			46			64		
Concrete pry-out failure											
Pry-out factor	k_8	[-]	1,0	2,0		1,0	2,0		1,0	2,0	
Concrete edge failure											
Effective length of fastener	l_f	[mm]	40	60	70	50	60	70	55	75	85
Outside diameter of fastener	d_{nom}	[mm]	8			8			10		

¹⁾ In absence of other national regulations.

Hilti screw anchor HUS4

Performances
Essential characteristics under static and quasi-static load in concrete

Annex C2

Table C2: Essential characteristics under static and quasi-static load in concrete for HUS4 carbon steel size 10 to 14

Fastener size HUS4			10			12			14				
Type			T-H(F), T-C			H(F)			H(F), A(F)				
Nominal embedment depth	h_{nom}	[mm]	h_{nom1}	h_{nom2}	h_{nom3}	h_{nom1}	h_{nom2}	h_{nom3}	h_{nom1}	h_{nom2}	h_{nom3}		
			55	75	85	60	80	100	65	85	115		
Adjustment													
Total max. thickness of adjustment layers	t_{adj}	[mm]	-	10	10	10	10	10	10	10	10		
Max. number of adjustments	n_{adj}	[-]	-	2	2	2	2	2	2	2	2		
Steel failure for tension load													
Characteristic resistance	$N_{Rk,s}$	[kN]	62,2			79,0			101,5				
Partial factor	$\gamma_{Ms,N}^{1)}$	[-]	1,4			1,5							
Pull-out failure													
Characteristic resistance in uncracked concrete C20/25	$N_{Rk,p,ucr}$	[kN]	12	20	32	$\geq N_{Rk,c}^{0,3)}$							
Characteristic resistance in cracked concrete C20/25	$N_{Rk,p,cr}$	[kN]	9	15	19	10	$\geq N_{Rk,c}^{0,3)}$						
Increasing factor for $N_{Rk,p} = N_{Rk,p(C20/25)} * \psi_c$	ψ_c	[-]	$(f_{ck}/20)^{0,5}$										
Concrete cone and splitting failure													
Effective embedment depth	$h_{ef}^{2)}$	[mm]	41,6	58,6	67,1	45,9	62,9	79,9	49,3	66,3	91,8		
Factor for	Uncracked	$k_{ucr,N}$	[-]			11,0							
	Cracked	$k_{cr,N}$	[-]			7,7							
Concrete cone failure	Edge distance	$c_{cr,N}$	[mm]			1,5 h_{ef}							
	Spacing	$s_{cr,N}$	[mm]			3 h_{ef}							
Characteristic resistance	$N_{Rk,sp}^{0)}$	[kN]	$\min(N_{Rk,p}; N_{Rk,c}^{2),3)})$										
Splitting failure	Edge distance	$c_{cr,sp}$	[mm]			1,60 h_{ef}			1,65 h_{ef}			1,60 h_{ef}	
	Spacing	$s_{cr,sp}$	[mm]			3,20 h_{ef}			3,30 h_{ef}			3,20 h_{ef}	
Installation factor	γ_{inst}	[-]	1,0										

¹⁾ In absence of other national regulations.

²⁾ In case $h_{nom} > h_{nom1}$ and $< h_{nom3}$ the actual h_{ef} for concrete failure can be calculated according to Tables A4, A5 or A7

³⁾ $N_{Rk,c}^{0)}$ for C20/25 according to EN 1992-4:2018

Hilti screw anchor HUS4

Performances

Essential characteristics under static and quasi-static load in concrete

Annex C3

Table C2 continued

Fastener size HUS4			10			12			14		
Type			T-H(F), T-C			H(F)			H(F), A(F)		
Nominal embedment depth	h_{nom}	[mm]	h_{nom1}	h_{nom2}	h_{nom3}	h_{nom1}	h_{nom2}	h_{nom3}	h_{nom1}	h_{nom2}	h_{nom3}
			55	75	85	60	80	100	65	85	115
Steel failure for shear load											
Characteristic resistance	$V_{RK,s}^0$	[kN]	30		34	38,9		44,9	55		62
Partial factor	$\gamma_{Ms,V}^{1)}$	[-]	1,50			1,25					
Ductility factor	k_7	[-]	0,8								
Characteristic resistance	$M_{RK,s}^0$	[Nm]	92			120			186		
Concrete pry-out failure											
Pry-out factor	k_8	[-]	1,0	2,0		2,0					
Concrete edge failure											
Effective length of fastener	l_f	[mm]	55	75	85	60	80	100	65	85	115
Outside diameter of fastener	d_{nom}	[mm]	10			12			14		

¹⁾ In absence of other national regulations.

Hilti screw anchor HUS4

Performances
Essential characteristics under static and quasi-static load in concrete

Annex C4

Table C3: Essential characteristics under static and quasi-static load in concrete for HUS4 carbon steel size 16

Fastener size HUS4			16		16			16
Type			H(F)		H(F) G02			DW
Nominal embedment depth	h_{nom}	[mm]	h_{nom1}	h_{nom2}	h_{nom1}	h_{nom2}	h_{nom3}	h_{nom}
			85	130	85	110	130	130
Adjustment								
Total max. thickness of adjustment layers	t_{adj}	[mm]	-	-	10	10	10	-
Max. number of adjustments	n_{adj}	[-]	-	-	2	2	2	-
Steel failure for tension load								
Characteristic resistance	$N_{Rk,s}$	[kN]	107,7		141,9			120,0
Partial factor	$\gamma_{Ms,N}^{1)}$	[-]	1,5		1,5			1,5
Pull-out failure								
Characteristic resistance in uncracked concrete C20/25	$N_{Rk,p,ucr}$	[kN]	22	46	$\geq N_{Rk,c}^{0(2),3)}$			$\geq N_{Rk,c}^{0(2),3)}$
Characteristic resistance in cracked concrete C20/25	$N_{Rk,p,cr}$	[kN]	16	32	$\geq N_{Rk,c}^{0(2),3)}$			$\geq N_{Rk,c}^{0(2),3)}$
Increasing factor for $N_{Rk,p} = N_{Rk,p(C20/25)} * \psi_c$	ψ_c	[-]	$(f_{ck}/20)^{0,5}$					
Concrete cone and splitting failure								
Effective embedment depth	$h_{ef}^{2)}$	[mm]	66,6	104,9	66,1	87,3	104,3	104,3
Factor for	Uncracked	$k_{ucr,N}$	-		11,0			-
	Cracked	$k_{cr,N}$	-		7,7			-
Concrete cone failure	Edge distance	$c_{cr,N}$	-		1,5 h_{ef}			-
	Spacing	$s_{cr,N}$	-		3 h_{ef}			-
Characteristic resistance	$N_{Rk,sp}^0$	[kN]	$\min(N_{Rk,p}; N_{Rk,c}^{0(2),3)}$					
Required splitting area	$A_{sp,rqd}$	[-]	-		$(N_{Rk,sp}^0 + 2,81) / 0,000745$			-
Splitting failure	Edge distance	$c_{cr,sp}$	1,60 h_{ef}		$\min \left[\frac{A_{sp,rqd} + 0,8 \cdot (h_{min} - h_{ef})^2}{3,41 \cdot h_{min} - 0,59 \cdot h_{ef}}; \frac{A_{sp,rqd}}{s_{min} \cdot \sqrt{8}} \right]$			$\geq (1,50 \cdot h_{ef})$
	Spacing	$s_{cr,sp}$	3,20 h_{ef}		2,00 $c_{cr,sp}$			-
Installation factor	γ_{inst}	[-]	1,0		1,0			-

¹⁾ In absence of other national regulations.

²⁾ In case $h_{nom} > h_{nom1}$ and $< h_{nom3}$ the actual h_{ef} for concrete failure and pullout can be calculated according to Table A5 or A8

³⁾ $N_{Rk,c}$ for C20/25 according to EN 1992-4:2018

Hilti screw anchor HUS4

Performances

Essential characteristics under static and quasi-static load in concrete

Annex C5

Table C3 continued

Fastener size HUS4			16		16			16
Type			H(F)		H(F) G02			DW
Nominal embedment depth	h_{nom}	[mm]	h_{nom1}	h_{nom2}	h_{nom1}	h_{nom2}	h_{nom3}	h_{nom}
			85	130	85	110	130	130
Steel failure for shear load								
Characteristic resistance	$V^0_{Rk,s}$	[kN]	65,1	73,1	77,8		82,9	60,0
Partial factor	$\gamma_{Ms,V}^{1)}$	[-]	1,25					
Ductility factor	k_7	[-]	0,8					
Characteristic resistance	$M^0_{Rk,s}$	[Nm]	240		350			283
Concrete pry-out failure								
Pry-out factor	k_8	[-]	2,0					
Concrete edge failure								
Effective length of fastener	l_f	[mm]	85	130	85	110	130	130
Outside diameter of fastener	d_{nom}	[mm]	16		16			16

¹⁾ In absence of other national regulations.

Hilti screw anchor HUS4

Performances
Essential characteristics under static and quasi-static load in concrete

Annex C6

Table C4: Essential characteristics under static and quasi-static load in concrete for HUS4 stainless steel

Fastener size HUS4			6		8		10		14	
Type			HR, CR		HR, CR		HR, CR		HR	
Nominal embedment depth h_{nom} [mm]			h_{nom1}	h_{nom1}	h_{nom2}	h_{nom1}	h_{nom2}	h_{nom1}	h_{nom2}	
			55	60	80	70	90	70	110	
Steel failure for tension and shear load										
Characteristic resistance $N_{Rk,s}$ [kN]			24,0	34,0	52,6	102,2				
Partial factor $\gamma_{Ms,N}^{1)}$ [-]			1,4							
Characteristic resistance $V_{Rk,s}$ [kN]			17,0	26,0	33,0	55,0	77,0			
Partial factor $\gamma_{Ms,V}^{1)}$ [-]			1,5							
Ductility factor k_7 [-]			1,0							
Characteristic resistance $M^0_{Rk,s}$ [Nm]			19	36	66	193				
Pull-out failure										
Characteristic resistance in cracked concrete C20/25 $N_{Rk,p,cr}$ [kN]			5	8,5	15	12	16	12	25	
Characteristic resistance in uncracked concrete C20/25 $N_{Rk,p,ucr}$ [kN]			9	12	16	16	25	$\geq N^0_{Rk,c}{}^{3)}$		
Increasing factor for $N_{Rk,p} = N_{Rk,p(C20/25)} * \psi_c$ ψ_c [-]			$(f_{ck}/20)^{0,5}$							
Concrete cone and splitting failure										
Effective anchorage depth $h_{ef}^{2)}$ [mm]			45	47	64	54	71	52	86	
Factor for Cracked $k_{cr,N}$ [-]			7,7							
Factor for Uncracked $k_{ucr,N}$ [-]			11,0							
Concrete cone failure Edge distance $c_{cr,N}$ [mm]			1,5 h_{ef}							
Concrete cone failure Spacing $s_{cr,N}$ [mm]			3 h_{ef}							
Characteristic resistance $N^0_{Rk,sp}$ [kN]			$N_{Rk,p}$							
Splitting failure Edge distance $c_{cr,sp}$ [mm]			1,5 h_{ef}	1,5 h_{ef}	1,8 h_{ef}	1,8 h_{ef}				
Splitting failure Spacing $s_{cr,sp}$ [mm]			3 h_{ef}	3 h_{ef}	3,6 h_{ef}	3,6 h_{ef}				
Robustness γ_{inst} [-]			1,4	1,0	1,2	1,2	1,0	1,2		
Concrete pry-out failure										
Pry-out factor k_8 [mm]			1,5	2,0						
Concrete edge failure										
Effective length of anchor l_f [mm]			55	60	80	70	90	70	110	
Effective diameter of anchor d_{nom} [mm]			6	8	10	14				

1) In absence of other national regulations.

2) In case $h_{nom} > h_{nom1}$ and $< h_{nom2}$ the actual h_{ef} for concrete failure can be calculated according to Tables A6 or A7

3) $N^0_{Rk,c}$ for C20/25 according to EN 1992-4:2018

Hilti screw anchor HUS4

Performances
Essential characteristics under static and quasi-static load in concrete

Annex C7

Table C5: Essential characteristics for seismic performance category C1 in concrete for HUS4 carbon steel size 8 to 10

Fastener size HUS4			8		8			10		
Type			H(F), C		T-H(F), T-C			H(F), C, A(F)		
Nominal embedment depth	h_{nom}	[mm]	h_{nom2}	h_{nom3}	h_{nom1}	h_{nom2}	h_{nom3}	h_{nom1}	h_{nom2}	h_{nom3}
			60	70	50	60	70	55	75	85
Adjustment										
Total max. thickness of adjustment layers	t_{adj}	[mm]	10	10	-	10	10	-	10	10
Max. number of adjustments	n_{adj}	[-]	2	2	-	2	2	-	2	2
Steel failure for tension and shear load										
Characteristic resistance	$N_{Rk,s,C1}$	[kN]	36,0		39,2			55,0		
Partial factor	$\gamma_{Ms,N}^{1)}$	[-]	1,5		1,4			1,5		
Characteristic resistance	$V_{Rk,s,C1}$	[kN]	18,8		16,5			26,1	26,7	
Partial factor	$\gamma_{Ms,V}^{1)}$	[-]	1,25		1,5			1,25		
Reduction factor acc. to EN 1992-4:2018 annular gap unfilled	α_{gap}	[-]				0,5				
Reduction factor acc. to EN 1992-4:2018 annular gap filled	α_{gap}	[-]				1,0				
Pull-out failure										
Characteristic resistance in cracked concrete	$N_{Rk,p,C1}$	[kN]	$\geq N_{Rk,c}^{0)3)}$		6	9	12	$\geq N_{Rk,c}^{0)3)}$		
Concrete cone failure										
Effective embedment depth	$h_{ef}^{2)}$	[mm]	47,6	56,1	40	46,4	54,9	42,5	59,5	68,0
Concrete cone failure	Edge distance	$c_{cr,N}$			1,5 h_{ef}					
	Spacing	$s_{cr,N}$			3 h_{ef}					
Installation factor	γ_{inst}	[-]	1,0					1,2	1,0	
Concrete pry-out failure										
Pry-out factor	k_8	[-]	2,0		1,0	2,0		1,0	2,0	
Concrete edge failure										
Effective length of fastener	l_f	[mm]	60	70	50	60	70	55	75	85
Outside diameter of fastener	d_{nom}	[mm]	8		8			10		

¹⁾ In absence of other national regulations.

²⁾ In case $h_{nom} > h_{nom1}$ and $< h_{nom3}$ the actual h_{ef} for concrete failure can be calculated according to Tables A4, A5 or A7

³⁾ $N_{Rk,c}^{0)}$ for C20/25 according to EN 1992-4:2018

Hilti screw anchor HUS4

Performances

Essential characteristics for seismic performance category C1 in concrete

Annex C8

Table C6: Essential characteristics for seismic performance category C1 in concrete for HUS4 carbon steel size 10 to 14

Fastener size HUS4			10			12			14		
Type			T-H(F), T-C			H(F)			H(F), A(F)		
Nominal embedment depth	h_{nom}	[mm]	h_{nom1}	h_{nom2}	h_{nom3}	h_{nom1}	h_{nom2}	h_{nom3}	h_{nom1}	h_{nom2}	h_{nom3}
			55	75	85	60	80	100	65	85	115
Adjustment											
Total max. thickness of adjustment layers	t_{adj}	[mm]	-	10	10	10	10	10	10	10	10
Max. number of adjustments	n_{adj}	[-]	-	2	2	2	2	2	2	2	2
Steel failure for tension and shear load											
Characteristic resistance	$N_{Rk,s,C1}$	[kN]	62,2			79,0			101,5		
Partial factor	$\gamma_{Ms,N}^{1)}$	[-]	1,5								
Characteristic resistance	$V_{Rk,s,C1}$	[kN]	25,7			33,2	38,9		46,0		
Partial factor	$\gamma_{Ms,V}^{1)}$	[-]	1,5			1,25					
Reduction factor acc. to EN 1992-4: 2018 annular gap unfilled	α_{gap}	[-]	0,5								
Reduction factor acc. to EN 1992-4: 2018 annular gap filled	α_{gap}	[-]	1,0								
Pull-out failure											
Characteristic resistance in cracked concrete	$N_{Rk,p,C1}$	[kN]	9	15	19	$\geq N_{Rk,c}^{0,3)}$					
Concrete cone failure											
Effective embedment depth	$h_{ef}^{2)}$	[mm]	41,6	58,6	67,1	45,9	62,9	79,9	49,3	66,3	91,8
Concrete cone failure	Edge distance	$c_{cr,N}$	1,5 h_{ef}								
	Spacing	$s_{cr,N}$	3 h_{ef}								
Installation factor	γ_{inst}	[-]	1,0								
Concrete pry-out failure											
Pry-out factor	k_8	[-]	1,0	2,0		2,0					
Concrete edge failure											
Effective length of fastener	l_f	[mm]	55	75	85	60	80	100	65	85	115
Outside diameter of fastener	d_{nom}	[mm]	10			12			14		

¹⁾ In absence of other national regulations.

²⁾ In case $h_{nom} > h_{nom1}$ and $< h_{nom3}$ the actual h_{ef} for concrete failure can be calculated according to Tables A4, A5 or A7

³⁾ $N_{Rk,c}^0$ for C20/25 according to EN 1992-4:2018

Hilti screw anchor HUS4

Performances
Essential characteristics for seismic performance category C1 in concrete

Annex C9

Table C7: Essential characteristics for seismic performance category C1 in concrete for HUS4 carbon steel size 16

Fastener size HUS4			16		16			16
Type			H(F)		H(F) G02			DW
Nominal embedment depth	h_{nom}	[mm]	h_{nom1}	h_{nom2}	h_{nom1}	h_{nom2}	h_{nom3}	h_{nom}
			85	130	85	110	130	130
Adjustment								
Total max. thickness of adjustment layers	t_{adj}	[mm]	-	-	10	10	10	10
Max. number of adjustments	n_{ad}	[-]	-	-	2	2	2	2
Steel failure for tension and shear load								
Characteristic resistance	$N_{Rk,s,C1}$	[kN]	107,7		141,9			120
Partial factor	$\gamma_{Ms,N}^{1)}$	[-]	1,5		1,5			1,5
Characteristic resistance	$V_{Rk,s,C1}$	[kN]	42,9	25,3	47,9	47,9	51,0	37,0
Partial factor	$\gamma_{Ms,V}^{1)}$	[-]	1,25					
Reduction factor acc. to EN 1992-4: 2018 annular gap unfilled	α_{gap}	[-]	0,5					
Reduction factor acc. to EN 1992-4: 2018 annular gap filled	α_{gap}	[-]	1,0					
Pull-out failure								
Characteristic resistance in cracked concrete	$N_{Rk,p,C1}$	[kN]	7,5	19,0	$\geq N_{Rk,c}^{0,2),3)}$			$\geq N_{Rk,c}^{0,2),3)}$
Concrete cone failure								
Effective embedment depth	$h_{ef}^{2)}$	[mm]	66,6	104,9	66,1	87,3	104,3	104,3
Concrete cone failure	Edge distance	$c_{cr,N}$	1,5 h_{ef}		1,5 h_{ef}			
	Spacing	$s_{cr,N}$	3 h_{ef}		3 h_{ef}			
Installation factor	γ_{inst}	[-]	1,0		1,0			
Concrete pry-out failure								
Pry-out factor	k_8	[-]	2,0					
Concrete edge failure								
Effective length of fastener	l_f	[mm]	85	130	85	110	130	130
Outside diameter of fastener	d_{nom}	[mm]	16					

1) In absence of other national regulations.

2) In case $h_{nom} > h_{nom1}$ and $< h_{nom3}$ the actual h_{ef} for concrete and pullout failure can be calculated according to Table A5

3) $N_{Rk,c}^0$ for C20/25 according to EN 1992-4:2018

Hilti screw anchor HUS4

Performances

Essential characteristics for seismic performance category C1 in concrete

Annex C10

Table C8: Essential characteristics for seismic performance category C1 in concrete for HUS4 stainless steel

Fastener size HUS4				8	10	14
Type				HR, CR	HR, CR	HR
Nominal embedment depth	h_{nom}	[mm]		h_{nom2}	h_{nom2}	h_{nom2}
				80	90	110
Steel failure for tension and shear load						
Characteristic resistance	$N_{RK,s,C1}$	[kN]		34,0	52,6	102,2
Partial factor	$\gamma_{Ms,N}^{1)}$	[-]		1,4		
Characteristic resistance	$V_{RK,s,C1}$	[kN]		11,1	17,9	53,9
Partial factor	$\gamma_{Ms,V}^{1)}$	[-]		1,5		
Pull-out failure						
Characteristic resistance in cracked concrete	$N_{RK,p,C1}$	[kN]		7,7	12,5	17,5
Concrete cone failure						
Effective embedment depth	h_{ef}	[mm]		64	71	86
Concrete cone failure	Edge distance	$c_{cr,N}$	[mm]	1,5 h_{ef}		
	Spacing	$s_{cr,N}$	[mm]	3 h_{ef}		
Robustness	γ_{inst}	[-]		1,2	1,0	1,2
Concrete pry-out failure						
Pry-out factor	k_8	[-]		2,0		
Concrete edge failure						
Effective length of fastener	$l_f = h_{ef}$	[mm]		64	71	86
Outside diameter of fastener	d_{nom}	[mm]		8	10	14

¹⁾ In absence of other national regulations.

Hilti screw anchor HUS4

Performances

Essential characteristics for seismic performance category C1 in concrete

Annex C11

Table C9: Essential characteristics for seismic performance category C2 in concrete for HUS4 carbon steel size 8 to 10

Fastener size HUS4			8		8			10		
Type			H(F), C		T-H(F), T-C			H(F), C, A(F)		
Nominal embedment depth	h_{nom}	[mm]	h_{nom2}	h_{nom3}	h_{nom1}	h_{nom2}	h_{nom3}	h_{nom1}	h_{nom2}	h_{nom3}
			60	70	50	60	70	55	75	85
Adjustment										
Total max. thickness of adjustment layers	t_{adj}	[mm]	10	10	-	10	10	-	10	10
Max. number of adjustments	n_{adj}	[-]	2	2	-	2	2	-	2	2
Steel failure for tension										
Characteristic resistance	$N_{Rk,s,C2}$	[kN]	36,0		39,2			55,0		
Partial factor	$\gamma_{Ms,N}^{1)}$	[-]	1,5		1,4			1,5		
Steel failure for shear load										
Partial factor	$\gamma_{Ms,V}^{1)}$	[-]	1,25		1,5			1,25		
Installation with Hilti filling set (HUS4-H and HUS4-A)										
Characteristic resistance	$V_{Rk,s,C2}$	[kN]	8,7	16,0	9,2	14,7	15,1	23,2		
Partial factor annular gap filled	α_{gap}	[-]	1,0							
Installation without Hilti filling set										
Characteristic resistance	$V_{Rk,s,C2}$	[kN]	8,7	10,8	9,2	10,8	14,8			
Partial factor annular gap not filled	α_{gap}	[-]	0,5							
Pull-out failure										
Characteristic resistance in cracked concrete	$N_{Rk,p,C2}$	[kN]	1,8	2,7	2,3	2,8	3,2	2,6	3,6	5,4
Concrete cone failure										
Effective embedment depth	$h_{ef}^{2)}$	[mm]	47,6	56,1	40	46,4	54,9	42,5	59,5	68,0
Concrete cone failure	Edge distance	$c_{cr,N}$	1,5 h_{ef}							
	Spacing	$s_{cr,N}$	3 h_{ef}							
Installation factor	γ_{inst}	[-]	1,0				1,2	1,0		
Concrete pry-out failure										
Pry-out factor	k_8	[-]	2,0		1,0	2,0		1,0	2,0	
Concrete edge failure										
Effective length of fastener	l_f	[mm]	60	70	50	60	70	55	75	85
Outside diameter of fastener	d_{nom}	[mm]	8		8			10		

¹⁾ In absence of other national regulations.

²⁾ In case $h_{nom} > h_{nom1}$ and $< h_{nom3}$ the actual h_{ef} for concrete failure can be calculated according to Tables A4, A5 or A7

Hilti screw anchor HUS4

Performances

Essential characteristics for seismic performance category C2 in concrete

Annex C12

Table C10: Essential characteristics for seismic performance category C2 in concrete for HUS4 carbon steel size 10 to 14

Fastener size HUS4			10			12			14		
Type			T-H(F), T-C			H(F)			H(F), A(F)		
Nominal embedment depth	h_{nom}	[mm]	h_{nom1}	h_{nom2}	h_{nom3}	h_{nom1}	h_{nom2}	h_{nom3}	h_{nom1}	h_{nom2}	h_{nom3}
			55	75	85	60	80	100	65	85	115
Adjustment											
Total max. thickness of adjustment layers	t_{adj}	[mm]	-	10	10	10	10	10	10	10	10
Max. number of adjustments	n_a	[-]	-	2	2	2	2	2	2	2	2
Steel failure for tension											
Characteristic resistance	$N_{Rk,s,C2}$	[kN]	62,2			79,0			101,5		
Partial factor	$\gamma_{Ms,N}^{1)}$	[-]	1,4			1,5					
Steel failure for shear load											
Partial factor	$\gamma_{Ms,V}^{1)}$	[-]	1,5			1,25					
Installation with Hilti filling set (HUS4-H and HUS4-A)											
Characteristic resistance	$V_{Rk,s,C2}$	[kN]	13,3	25,6		20,0	28,6		29,2	46,5	
Partial factor annular gap filled	α_{gap}	[-]				1,0					
Installation without Hilti filling set											
Characteristic resistance	$V_{Rk,s,C2}$	[kN]	13,3	17,7		20,0	23,7		29,2	34,4	
Partial factor annular gap not filled	α_{gap}	[-]				0,5					
Pull-out failure											
Characteristic resistance in cracked concrete	$N_{Rk,p,C2}$	[kN]	2,8	5,4	6,4	5,7	8,5	11,4	5,4	8,9	17,7
Concrete cone failure											
Effective embedment depth	$h_{ef}^{2)}$	[mm]	41,6	58,6	67,1	45,9	62,9	79,9	49,3	66,3	91,8
Concrete cone failure	Edge distance	$c_{cr,N}$				1,5 h_{ef}					
	Spacing	$s_{cr,N}$				3 h_{ef}					
Installation factor	γ_{inst}	[-]				1,0					
Concrete pry-out failure											
Pry-out factor	k_8	[-]	1,0	2,0		2,0					
Concrete edge failure											
Effective length of fastener	l_f	[mm]	55	75	85	60	80	100	65	85	115
Outside diameter of fastener	d_{nom}	[mm]	10			12			14		

¹⁾ In absence of other national regulations.

²⁾ In case $h_{nom} > h_{nom1}$ and $< h_{nom3}$ the actual h_{ef} for concrete failure can be calculated according to Tables A4, A5 or A7

Hilti screw anchor HUS4

Performances

Essential characteristics for seismic performance category C2 in concrete

Annex C13

Table C11: Essential characteristics for seismic performance category C2 in concrete for HUS4 carbon steel size 16

Fastener size HUS4		16			16
Type		H(F) G02			DW
Nominal embedment depth	h_{nom} [mm]	h_{nom1}	h_{nom2}	h_{nom3}	h_{nom3}
		85	110	130	130
Adjustment					
Total max. thickness of adjustment layers	t_{adj} [mm]	10	10	10	10
Max. number of adjustments	n_a [-]	2	2	2	2
Steel failure for tension load					
Characteristic resistance	$N_{RK,s,C2}$ [kN]	141,9			120
Partial factor	$\gamma_{Ms,N}^{1)}$ [-]	1,5			
Steel failure for shear load					
Partial factor	$\gamma_{Ms,V}^{1)}$ [-]	1,25			
Installation with Hilti filling set					
Characteristic resistance	$V_{RK,s,C2}$ [kN]	58,1	58,1	61,8	44,0
Partial factor annular gap filled	α_{gap} [-]	1,0			
Installation without Hilti filling set					
Characteristic resistance	$V_{RK,s,C2}$ [kN]	58,1	58,1	61,8	44,0
Partial factor annular gap not filled	α_{gap} [-]	0,5			
Pull-out failure					
Characteristic resistance in cracked concrete	$N_{RK,p,C2}$ [kN]	11,7	20,1	25,8	25,8
Concrete cone failure					
Effective embedment depth	$h_{ef}^{2)}$ [mm]	66,1	87,3	104,3	104,3
Concrete cone failure	Edge distance	$c_{cr,N}$ [mm]	1,5 h_{ef}		
	Spacing	$s_{cr,N}$ [mm]	3 h_{ef}		
Installation factor	γ_{inst} [-]	1,0			
Concrete pry-out failure					
Pry-out factor	k_8 [-]	2,0			
Concrete edge failure					
Effective length of fastener	l_f [mm]	85	110	130	130
Outside diameter of fastener	d_{nom} [mm]	16			

¹⁾ In absence of other national regulations.

²⁾ In case $h_{nom} > h_{nom1}$ and $< h_{nom3}$ the actual h_{ef} for concrete failure can be calculated according to Table A6 or A8

Hilti screw anchor HUS4

Annex C14

Performances
Essential characteristics for seismic performance category C2 in concrete

Table C12: Essential characteristics under fire exposure in concrete for HUS4 (T)-H carbon steel sizes 8 and 10

Fastener size HUS4 (T)-H(F)			8			T-8			10		
			h_{nom1}	h_{nom2}	h_{nom3}	h_{nom1}	h_{nom2}	h_{nom3}	h_{nom1}	h_{nom2}	h_{nom3}
Nominal embedment depth	h_{nom}	[mm]	40	60	70	50	60	70	55	75	85
Adjustment											
Total max. thickness of adjustment layers	t_{adj}	[mm]	-	10	10	-	10	10	-	10	10
Max. number of adjustments	n_a	[-]	-	2	2	-	2	2	-	2	2
Steel failure for tension and shear load ($F_{Rk,s,fi} = N_{Rk,s,fi} = V_{Rk,s,fi}$)											
Characteristic resistance	R30	$F_{Rk,s,fi}$ [kN]	2,6			3,2	3,5	3,8	4,1	4,2	
	R60	$F_{Rk,s,fi}$ [kN]	1,9			2,4	2,6	2,8	3,1	3,1	
	R90	$F_{Rk,s,fi}$ [kN]	1,2			1,6	1,6	1,9	2,2	2,3	
	R120	$F_{Rk,s,fi}$ [kN]	0,9			1,2	1,2	1,5	1,5	1,7	
	R30	$M^0_{Rk,s,fi}$ [Nm]	2,3			3,8	4,1	4,4	4,8	4,9	
	R60	$M^0_{Rk,s,fi}$ [Nm]	1,7			2,8	3,0	3,4	3,6	3,7	
	R90	$M^0_{Rk,s,fi}$ [Nm]	1,1			1,9	1,9	2,3	2,6	2,7	
	R120	$M^0_{Rk,s,fi}$ [Nm]	0,8			1,5	1,4	1,7	1,8	1,9	
Pull-out failure											
Characteristic resistance	R30	$N^0_{Rk,p,fi}$ [kN]	1,3	2,8	3,6	1,5	2,3	3,0	2,3	3,9	4,7
	R60										
	R90										
	R120	$N^0_{Rk,p,fi}$ [kN]	1,0	2,2	2,8	1,2	1,8	2,4	1,9	3,1	3,7
Concrete cone failure											
Characteristic resistance	R30	$N^0_{Rk,c,fi}$ [kN]	0,8	2,6	4,0	1,8	2,6	4,0	2,0	4,7	6,5
	R60										
	R90										
	R120	$N^0_{Rk,c,fi}$ [kN]	0,7	2,1	3,2	1,4	2,1	3,2	1,6	3,7	5,2
Edge distance											
R30 to R120	$C_{cr,fi}$	[mm]	2 h_{ef}								
In case of fire attack from more than one side, the minimum edge distance shall be ≥ 300 mm											
Fastener spacing											
R30 to R120	$S_{cr,fi}$	[mm]	2 $C_{cr,fi}$								
Concrete pry-out failure											
R30 to R120	k_8	[-]	1,0	2,0	1,0	2,0	1,0	2,0	1,0	2,0	
The anchorage depth shall be increased for wet concrete by at least 30 mm compared to the given value											

Hilti screw anchor HUS4

Performances
Essential characteristics under fire exposure in concrete

Annex C15

Table C13: Essential characteristics under fire exposure in concrete for HUS4 (T)-H carbon steel sizes 10 to 14

Fastener size HUS4 (T)-H(F)				T-10			12			14		
				h_{nom1}	h_{nom2}	h_{nom3}	h_{nom1}	h_{nom2}	h_{nom3}	h_{nom1}	h_{nom2}	h_{nom3}
Nominal embedment depth	h_{nom}	[mm]		55	75	85	60	80	100	65	85	115
Adjustment												
Total max. thickness of adjustment layers	t_{adj}	[mm]		-	10	10	10	10	10	10	10	10
Max. number of adjustments	n_a	[-]		-	2	2	2	2	2	2	2	2
Steel failure for tension and shear load ($F_{Rk,s,fi} = N_{Rk,s,fi} = V_{Rk,s,fi}$)												
Characteristic resistance	R30	$F_{Rk,s,fi}$	[kN]	6,1	6,2	7,5	7,6	7,6	10,3	10,4	10,5	
	R60	$F_{Rk,s,fi}$	[kN]	4,6	4,7	5,5	5,7	5,8	7,7	7,9	8,0	
	R90	$F_{Rk,s,fi}$	[kN]	3,1	3,2	3,7	3,9	4,1	5,2	5,6	5,8	
	R120	$F_{Rk,s,fi}$	[kN]	2,4	2,5	2,8	3,0	3,1	3,9	4,2	4,4	
	R30	$M^0_{Rk,s,fi}$	[Nm]	9,1	9,2	11,4	11,6	11,6	18,9	19,2	19,3	
	R60	$M^0_{Rk,s,fi}$	[Nm]	6,9	7,0	8,4	8,8	8,9	14,1	14,6	14,8	
	R90	$M^0_{Rk,s,fi}$	[Nm]	4,6	4,8	5,7	6,0	6,2	9,5	10,2	10,7	
	R120	$M^0_{Rk,s,fi}$	[Nm]	3,5	3,7	4,3	4,6	4,7	7,2	7,7	8,1	
Pull-out failure												
Characteristic resistance	R30	$N^0_{Rk,p,fi}$	[kN]	2,4	4,0	4,9	2,6	4,2	6,1	2,9	4,5	7,5
	R60											
	R90											
	R120	$N^0_{Rk,p,fi}$	[kN]	1,9	3,2	3,9	2,1	3,4	4,9	2,3	3,6	6,0
Concrete cone failure												
Characteristic resistance	R30	$N^0_{Rk,c,fi}$	[kN]	2,0	4,7	6,6	2,4	5,4	9,8	2,9	6,1	13,9
	R60											
	R90											
	R120	$N^0_{Rk,c,fi}$	[kN]	1,6	3,8	5,3	1,9	4,3	7,8	2,3	4,9	11,1
Edge distance												
R30 to R120	$c_{cr,fi}$	[mm]		2 h_{ef}								
In case of fire attack from more than one side, the minimum edge distance shall be ≥ 300 mm												
Fastener spacing												
R30 to R120	$s_{cr,fi}$	[mm]		2 $c_{cr,fi}$								
Concrete pry-out failure												
R30 to R120	k_8	[-]		1,0	2,0	2,0						
The anchorage depth shall be increased for wet concrete by at least 30 mm compared to the given value												

Hilti screw anchor HUS4

Performances
Essential characteristics under fire exposure in concrete

Annex C16

**Table C14: Essential characteristics under fire exposure in concrete for HUS4-H
carbon steel size 16**

Fastener size HUS4-H(F) (G02)			H(F) 16		H(F) 16 G02			DW 16	
			h_{nom1}	h_{nom2}	h_{nom1}	h_{nom2}	h_{nom3}	h_{nom3}	
Nominal embedment depth	h_{nom}	[mm]	85	130	85	110	130	130	
Adjustment									
Total max. thickness of adjustment layers	t_{adj}	[mm]	-	-	10	10	10	10	
Max. number of adjustments	n_a	[-]	-	-	2	2	2	2	
Steel failure for tension and shear load ($F_{Rk,s,fi} = N_{Rk,s,fi} = V_{Rk,s,fi}$)									
Characteristic resistance	R30	$F_{Rk,s,fi}$	[kN]	10,6	10,7	10,6	10,6	10,7	3,9
	R60	$F_{Rk,s,fi}$	[kN]	8,1	8,2	8,1	8,1	8,2	2,9
	R90	$F_{Rk,s,fi}$	[kN]	5,7	5,9	5,7	5,7	5,9	2,5
	R120	$F_{Rk,s,fi}$	[kN]	4,3	4,5	4,3	4,3	4,5	2,0
	R30	$M^0_{Rk,s,fi}$	[Nm]	23,7	23,9	23,7	23,7	23,9	9,2
	R60	$M^0_{Rk,s,fi}$	[Nm]	18,1	18,3	18,1	18,1	18,3	6,9
	R90	$M^0_{Rk,s,fi}$	[Nm]	12,7	13,2	12,7	12,7	13,2	6,0
	R120	$M^0_{Rk,s,fi}$	[Nm]	9,6	10,0	9,6	9,6	10,0	4,6
Pull-out failure									
Characteristic resistance	R30	$N^0_{Rk,p,fi}$	[kN]	4,6	8,7	5,1	9,1	11,7	11,7
	R60			4,6	8,7	5,1	9,1	11,7	11,7
	R90			4,6	8,7	5,1	9,1	11,7	11,7
	R120			3,7	7,0	4,1	7,3	9,4	9,4
Concrete cone failure									
Characteristic resistance	R30	$N^0_{Rk,c,fi}$	[kN]	6,2	19,4	6,1	12,3	19,1	19,1
	R60			6,2	19,4	6,1	12,3	19,1	19,1
	R90			6,2	19,4	6,1	12,3	19,1	19,1
	R120			4,9	15,5	4,9	9,8	15,3	15,3
Edge distance									
R30 to R120	$c_{cr,fi}$	[mm]	2 h_{ef}						
In case of fire attack from more than one side, the minimum edge distance shall be ≥ 300 mm									
Fastener spacing									
R30 to R120	$s_{cr,fi}$	[mm]	2 $c_{cr,fi}$						
Concrete pry-out failure									
R30 to R120	k_8	[-]	2,0						
The anchorage depth shall be increased for wet concrete by at least 30 mm compared to the given value									

Hilti screw anchor HUS4

Performances
Essential characteristics under fire exposure in concrete

Annex C17

Table C15: Essential characteristics under fire exposure in concrete for HUS4 (T)-C carbon steel size 8

Fastener size HUS4 (T)-C				8			T-8		
				h_{nom1}	h_{nom2}	h_{nom3}	h_{nom1}	h_{nom2}	h_{nom3}
Nominal embedment depth	h_{nom}	[mm]	40	60	70	50	60	70	
Adjustment									
Total max. thickness of adjustment layers	t_{adj}	[mm]	-	10	10	-	10	10	
Max. number of adjustments	n_a	[-]	-	2	2	-	2	2	
Steel failure for tension and shear load ($F_{Rk,s,fi} = N_{Rk,s,fi} = V_{Rk,s,fi}$)									
Characteristic resistance	R30	$F_{Rk,s,fi}$	[kN]	0,5			0,5		
	R60	$F_{Rk,s,fi}$	[kN]	0,4			0,4		
	R90	$F_{Rk,s,fi}$	[kN]	0,3			0,3		
	R120	$F_{Rk,s,fi}$	[kN]	0,2			0,2		
	R30	$M^0_{Rk,s,fi}$	[Nm]	0,4			0,6		
	R60	$M^0_{Rk,s,fi}$	[Nm]	0,3			0,5		
	R90	$M^0_{Rk,s,fi}$	[Nm]	0,2			0,4		
	R120	$M^0_{Rk,s,fi}$	[Nm]	0,2			0,3		
Pull-out failure									
Characteristic resistance	R30	$N^0_{Rk,p,fi}$	[kN]	1,3	2,8	3,6	1,5	2,3	3,0
	R60								
	R90								
	R120	$N^0_{Rk,p,fi}$	[kN]	1,0	2,2	2,8	1,2	1,8	2,4
Concrete cone failure									
Characteristic resistance	R30	$N^0_{Rk,c,fi}$	[kN]	0,8	2,6	4,0	1,8	2,6	4,0
	R60								
	R90								
	R120	$N^0_{Rk,c,fi}$	[kN]	0,7	2,1	3,2	1,5	2,1	3,2
Edge distance									
R30 to R120	$C_{cr,fi}$	[mm]	2 h_{ef}						
In case of fire attack from more than one side, the minimum edge distance shall be ≥ 300 mm									
Fastener spacing									
R30 to R120	$S_{cr,fi}$	[mm]	2 $C_{cr,fi}$						
Concrete pry-out failure									
R30 to R120	k_8	[-]	1,0	2,0		1,0	2,0		
The anchorage depth shall be increased for wet concrete by at least 30 mm compared to the given value									

Hilti screw anchor HUS4

Performances
Essential characteristics under fire exposure in concrete

Annex C18

Table C16: Essential characteristics under fire exposure in concrete for HUS4 (T)-C carbon steel size 10

Fastener size HUS4 (T)-C				10			T-10			
				h_{nom1}	h_{nom2}	h_{nom3}	h_{nom1}	h_{nom2}	h_{nom3}	
Nominal embedment depth	h_{nom}	[mm]		55	75	85	55	75	85	
Adjustment										
Total max. thickness of adjustment layers	t_{adj}	[mm]		-	10	10	-	10	10	
Max. number of adjustments	n_a	[-]		-	2	2	-	2	2	
Steel failure for tension and shear load ($F_{Rk,s,fi} = N_{Rk,s,fi} = V_{Rk,s,fi}$)										
Characteristic resistance	R30	$F_{Rk,s,fi}$	[kN]		1,0			1,2		
	R60	$F_{Rk,s,fi}$	[kN]		0,9			1,0		
	R90	$F_{Rk,s,fi}$	[kN]		0,7			0,8		
	R120	$F_{Rk,s,fi}$	[kN]		0,6			0,6		
	R30	$M^0_{Rk,s,fi}$	[Nm]		1,2			1,7		
	R60	$M^0_{Rk,s,fi}$	[Nm]		1,0			1,5		
	R90	$M^0_{Rk,s,fi}$	[Nm]		0,8			1,1		
	R120	$M^0_{Rk,s,fi}$	[Nm]		0,6			0,9		
Pull-out failure										
Characteristic resistance	R30	$N^0_{Rk,p,fi}$	[kN]							
	R60			2,3	3,9	4,7	2,4	4,0	5,0	
	R90									
	R120	$N^0_{Rk,p,fi}$	[kN]	1,9	3,1	3,7	1,9	3,2	4,0	
Concrete cone failure										
Characteristic resistance	R30	$N^0_{Rk,c,fi}$	[kN]							
	R60			2,0	4,7	6,5	2,0	4,7	6,6	
	R90									
	R120	$N^0_{Rk,c,fi}$	[kN]	1,6	3,7	5,2	1,6	3,8	5,3	
Edge distance										
R30 to R120	$C_{cr,fi}$	[mm]		2 h_{ef}						
In case of fire attack from more than one side, the minimum edge distance shall be ≥ 300 mm										
Fastener spacing										
R30 to R120	$S_{cr,fi}$	[mm]		2 $C_{cr,fi}$						
Concrete pry-out failure										
R30 to R120	k_8	[-]		1,0	2,0		1,0	2,0		
The anchorage depth shall be increased for wet concrete by at least 30 mm compared to the given value										

Hilti screw anchor HUS4

Performances
Essential characteristics under fire exposure in concrete

Annex C19

Table C17: Essential characteristics under fire exposure in concrete for HUS4-A carbon steel

Fastener size HUS4-A(F)			10			14		
			h_{nom1}	h_{nom2}	h_{nom3}	h_{nom1}	h_{nom2}	h_{nom3}
Nominal embedment depth	h_{nom}	[mm]	55	75	85	65	85	115
Adjustment								
Total max. thickness of adjustment layers	t_{adj}	[mm]	-	10	10	10	10	10
Max. number of adjustments	n_a	[-]	-	2	2	2	2	2
Steel failure for tension and shear load ($F_{Rk,s,fi} = N_{Rk,s,fi} = V_{Rk,s,fi}$)								
Characteristic resistance	R30	$F_{Rk,s,fi}$ [kN]	4,2			8,4		
	R60	$F_{Rk,s,fi}$ [kN]	3,3			6,8		
	R90	$F_{Rk,s,fi}$ [kN]	2,5			5,1		
	R120	$F_{Rk,s,fi}$ [kN]	2,1			4,3		
	R30	$M^0_{Rk,s,fi}$ [Nm]	4,8			15,4		
	R60	$M^0_{Rk,s,fi}$ [Nm]	3,8			12,4		
	R90	$M^0_{Rk,s,fi}$ [Nm]	2,9			9,3		
	R120	$M^0_{Rk,s,fi}$ [Nm]	2,4			7,8		
Pull-out failure								
Characteristic resistance	R30	$N^0_{Rk,p,fi}$ [kN]	2,3	3,9	4,7	2,9	4,5	7,5
	R60							
	R90							
	R120	$N^0_{Rk,p,fi}$ [kN]	1,9	3,1	3,7	2,3	3,6	6,0
Concrete cone failure								
Characteristic resistance	R30	$N^0_{Rk,c,fi}$ [kN]	2,0	4,7	6,5	2,9	6,1	13,9
	R60							
	R90							
	R120	$N^0_{Rk,c,fi}$ [kN]	1,6	3,7	5,2	2,3	4,9	11,1
Edge distance								
R30 to R120	$c_{cr,fi}$	[mm]	2 h_{ef}					
In case of fire attack from more than one side, the minimum edge distance shall be ≥ 300 mm								
Fastener spacing								
R30 to R120	$s_{cr,fi}$	[mm]	2 $c_{cr,fi}$					
Concrete pry-out failure								
R30 to R120	k_8	[-]	1,0	2,0				
The anchorage depth shall be increased for wet concrete by at least 30 mm compared to the given value								

Hilti screw anchor HUS4

Performances
Essential characteristics under fire exposure in concrete

Annex C20

Table C18: Essential characteristics under fire exposure in concrete for HUS4 stainless steel

Fastener size HUS4			6		8				10				14	
			HR	CR	HR		CR		HR		CR		HR	
Type			h_{nom1}		h_{nom1}	h_{nom2}	h_{nom1}	h_{nom2}	h_{nom1}	h_{nom2}	h_{nom1}	h_{nom2}	h_{nom1}	h_{nom2}
Nominal embedment depth	h_{nom}	[mm]	55		60	80	60	80	70	90	70	90	70	110
Steel failure for tension and shear load ($F_{Rk,s,fi} = N_{Rk,s,fi} = V_{Rk,s,fi}$)														
Characteristic resistance	R30	$F_{Rk,s,fi}$	[kN]	4,9	0,2	9,3	0,8	18,5	1,4	41,7				
	R60	$F_{Rk,s,fi}$	[kN]	3,3	0,2	6,3	0,6	12,0	1,1	26,9				
	R90	$F_{Rk,s,fi}$	[kN]	1,8	0,2	3,2	0,5	5,4	0,9	12,2				
	R120	$F_{Rk,s,fi}$	[kN]	1,0	0,1	1,7	0,4	2,4	0,8	5,4				
	R30	$M^0_{Rk,s,fi}$	[Nm]	4,0	0,2	8,2	0,8	19,4	1,5	65,6				
	R60	$M^0_{Rk,s,fi}$	[Nm]	2,7	0,2	5,5	0,7	12,6	1,2	42,4				
	R90	$M^0_{Rk,s,fi}$	[Nm]	1,4	0,1	2,8	0,5	5,7	0,9	19,2				
	R120	$M^0_{Rk,s,fi}$	[Nm]	0,8	0,1	1,5	0,4	2,5	0,8	8,5				
Concrete pull-out failure														
Characteristic resistance	R30	$N_{Rk,p,fi}$	[kN]	1,3	1,5	3,0	1,5	3,0	2,3	4,0	2,3	4,0	3,0	6,3
	R60													
	R90													
	R120													
Edge distance														
R30 to R120	$c_{cr,fi}$	[mm]	2 h_{ef}											
Anchor spacing														
R30 to R120	$s_{cr,fi}$	[mm]	2 $c_{cr,fi}$											
Concrete pry-out failure														
R30 to R120	k_8	[-]	1,5	2,0										

Hilti screw anchor HUS4

Performances
Essential characteristics under fire exposure in concrete

Annex C21

Table C19: Displacements under tension loads for HUS4 carbon steel

Fastener size HUS4				8			8			10		
Type				H(F), C			T-H(F), T-C			H(F), C, A(F)		
				h_{nom1}	h_{nom2}	h_{nom3}	h_{nom1}	h_{nom2}	h_{nom3}	h_{nom1}	h_{nom2}	h_{nom3}
Nominal embedment depth		h_{nom}	[mm]	40	60	70	50	60	70	55	75	85
Cracked concrete C20/25 to C50/60	Tension Load	N	[kN]	2,6	5,4	6,9	4,3	5,7	7,6	3,8	7,5	8,6
		Displacement	δ_{N0}	[mm]	0,1	0,3	0,4	0,3	0,4	0,3	0,2	0,4
	$\delta_{N\infty}$		[mm]	0,3	0,4	0,4	0,7	0,7	0,6	0,7	0,7	0,9
Uncracked concrete C20/25 to C50/60	Tension Load	N	[kN]	3,7	7,1	9,1	6,6	8,9	11,8	5,2	10,5	12,2
		Displacement	δ_{N0}	[mm]	0,1	0,2	0,2	0,1	0,2	0,1	0,1	0,3
	$\delta_{N\infty}$		[mm]	0,3	0,4	0,4	0,3	0,3	0,3	0,7	0,7	0,9

Fastener size HUS4				10			12			14		
Type				T-H(F), T-C			H			H(F), A(F)		
				h_{nom1}	h_{nom2}	h_{nom3}	h_{nom1}	h_{nom2}	h_{nom3}	h_{nom1}	h_{nom2}	h_{nom3}
Nominal embedment depth		h_{nom}	[mm]	55	75	85	60	80	100	65	85	115
Cracked concrete C20/25 to C50/60	Tension Load	N	[kN]	5,7	9,5	13,2	5,1	8,2	11,7	5,7	8,6	14,4
		Displacement	δ_{N0}	[mm]	0,4	0,4	0,4	0,3	0,4	0,6	0,3	0,4
	$\delta_{N\infty}$		[mm]	0,4	0,4	0,5	0,9	0,9	1,2	1,3	1,3	1,5
Uncracked concrete C20/25 to C50/60	Tension Load	N	[kN]	8,7	14,8	20,5	6,8	10,8	15,5	7,5	11,7	19,1
		Displacement	δ_{N0}	[mm]	0,1	0,1	0,1	0,2	0,3	0,4	0,2	0,3
	$\delta_{N\infty}$		[mm]	0,2	0,2	0,2	0,9	0,9	1,2	1,3	1,3	1,5

Fastener size HUS4				16		16			16
Type				H(F)		H(F) G02			DW
				h_{nom1}	h_{nom2}	h_{nom1}	h_{nom2}	h_{nom3}	h_{nom}
Nominal embedment depth		h_{nom}	[mm]	85	130	85	110	130	130
Cracked concrete C20/25 to C50/60	Tension Load	N	[kN]	8,7	16,7	8,8	13,4	17,5	17,5
		Displacement	δ_{N0}	[mm]	0,1	0,4	0,14	0,17	0,18
	$\delta_{N\infty}$		[mm]	1,3	1,4	0,88	1,07	1,11	1,11
Uncracked concrete C20/25 to C50/60	Tension Load	N	[kN]	11,5	22,9	12,6	19,1	25,0	25,0
		Displacement	δ_{N0}	[mm]	0,4	0,3	0,12	0,14	0,15
	$\delta_{N\infty}$		[mm]	1,3	1,4	0,56	0,56	0,56	0,56

Hilti screw anchor HUS4

Performances
Displacement values in case of static and quasi-static loading

Annex C22

Table C20: Displacements under tension loads for HUS4 stainless steel

Fastener size HUS			6	8		10				14	
Type			HR, CR	HR, CR		HR, CR		H		HR	
			h_{nom1}	h_{nom1}	h_{nom2}	h_{nom1}	h_{nom2}	h_{nom1}	h_{nom2}	h_{nom1}	h_{nom2}
Nominal anchorage depth h_{nom} [mm]			55	60	80	70	90	70	85	70	110
Cracked concrete C20/25 to C50/60	Tension load	N [kN]	1,7	2,4	4,8	3,6	6,3	3,0	4,1	4,8	9,9
	Displacement	δ_{N0} [mm]	0,4	0,5	0,7	0,3	0,6	0,2	0,3	0,9	1,4
		$\delta_{N,seis}$ [mm]	1) ¹⁾	1) ¹⁾	1,2	1) ¹⁾	1,2	1) ¹⁾	1,2	1) ¹⁾	0,4
Uncracked concrete C20/25 to C50/60	Tension load	N [kN]	3,1	4,8	6,3	6,3	9,9	4,8	6,8	7,5	16,0
	Displacement	δ_{N0} [mm]	0,8	0,7	1,6	0,3	1,3	0,2	0,3	0,7	1,0
		$\delta_{N,seis}$ [mm]	0,8	0,7	1,6	0,3	1,3	0,3	0,7	0,7	1,0

¹⁾ No performance assessed.

Hilti screw anchor HUS4

Performances
Displacement values in case of static and quasi-static loading

Annex C23

Table C21: Displacements under shear loads for HUS4 carbon steel

Fastener size HUS4				8			8			10		
Type				H(F), C			T-H(F), T-C			H(F), C, A(F)		
				h_{nom1}	h_{nom2}	h_{nom3}	h_{nom1}	h_{nom2}	h_{nom3}	h_{nom1}	h_{nom2}	h_{nom3}
Nominal embedment depth		h_{nom}	[mm]	40	60	70	40	60	70	55	75	85
Concrete C20/25 to C50/60	Shear Load	V	[kN]	10,7	10,7	12,5	8,1	8,1	8,1	16,5	16,5	18,3
	Displacement	δ_{V0}	[mm]	1,3	1,1	0,9	2,5	3,4	2,9	1,4	1,3	1,0
		$\delta_{V\infty}$	[mm]	2,0	1,7	1,4	3,7	5,1	4,4	2,1	2,0	1,5

Fastener size HUS4				10			12			14		
Type				T-H(F), T-C			H(F)			H(F), A(F)		
				h_{nom1}	h_{nom2}	h_{nom3}	h_{nom1}	h_{nom2}	h_{nom3}	h_{nom1}	h_{nom2}	h_{nom3}
Nominal embedment depth		h_{nom}	[mm]	55	75	85	60	80	100	65	85	115
Concrete C20/25 to C50/60	Shear Load	V	[kN]	13,3			22,2	22,2	25,7	31,4	35,4	35,4
	Displacement	δ_{V0}	[mm]	3,8	3,7	3,2	1,6	1,6	0,9	5,3	5,3	4,0
		$\delta_{V\infty}$	[mm]	5,7	5,5	4,9	2,3	2,4	1,4	7,9	7,9	6,0

Fastener size HUS4				16		16			16
Type				H(F)		H(F) G02			DW
				h_{nom1}	h_{nom2}	h_{nom1}	h_{nom2}	h_{nom3}	h_{nom}
Nominal embedment depth		h_{nom}	[mm]	85	130	85	110	130	130
Concrete C20/25 to C50/60	Shear Load	V	[kN]	37,2	41,8	44,5	44,5	44,5	44,5
	Displacement	δ_{V0}	[mm]	2,3	1,8	3,5	3,5	3,5	3,5
		$\delta_{V\infty}$	[mm]	3,5	2,7	5,3	5,3	5,3	5,3

Table C22: Displacements under shear loads for HUS4 stainless steel

Fastener size HUS4				6		8		10		14	
Type				HR, CR		HR, CR		HR, CR		HR	
				h_{nom1}	h_{nom2}	h_{nom1}	h_{nom2}	h_{nom1}	h_{nom2}	h_{nom1}	h_{nom2}
Nominal anchorage depth		h_{nom}	[mm]	55	60	80	70	90	70	110	
Concrete C20/25 to C50/60	Shear load	V	[kN]	7,8	11,0	12,4	13,6	15,7	12,9	27,3	
	Displacement	δ_{V0}	[mm]	0,4	2,0	2,3	1,1	1,7	3,5	3,9	
		$\delta_{V\infty}$	[mm]	0,5	2,4	2,9	1,5	2,4	3,9	4,3	
		$\delta_{V,C1}$	[mm]	1)	1)	4,8	1)	5,3	1)	7,6	

1) No performance assessed.

Hilti screw anchor HUS4

Annex C24

Performances
Displacement values in case of static and quasi-static loading

Table C23: Displacements under tension and shear loads for seismic category C2 for HUS 4 carbon steel

Fastener size HUS4			8		8			10		
Type			H(F), C		T-H(F), T-C			H(F), C, A(F)		
			h_{nom2}	h_{nom3}	h_{nom1}	h_{nom2}	h_{nom3}	h_{nom1}	h_{nom2}	h_{nom3}
Nominal embedment depth	h_{nom}	[mm]	60	70	50	60	70	55	75	85
Tension load										
Displacement DLS	$\delta_{N,C2 (DLS)}$	[mm]	0,59		0,35			0,80		
Displacement ULS	$\delta_{N,C2 (ULS)}$	[mm]	1,36		0,65			3,66		
Shear load with Hilti filling set (HUS4-H and HUS4-A)										
Displacement DLS	$\delta_{V,C2 (DLS)}$	[mm]	3,57	1,85	3,37	1,81	4,32	1,72		
Displacement ULS	$\delta_{V,C2 (ULS)}$	[mm]	5,56	5,44	5,38	4,60	7,72	6,88		
Shear load without Hilti filling set										
Displacement DLS	$\delta_{V,C2 (DLS)}$	[mm]	3,57	4,64	3,37	3,93	4,32	5,02		
Displacement ULS	$\delta_{V,C2 (ULS)}$	[mm]	5,56	7,96	5,38	5,55	7,72	8,97		

Fastener size HUS4			10			12			14		
Type			T-H(F), T-C			H(F)			H(F), A(F)		
			h_{nom1}	h_{nom2}	h_{nom3}	h_{nom1}	h_{nom2}	h_{nom3}	h_{nom1}	h_{nom2}	h_{nom3}
Nominal embedment depth	h_{nom}	[mm]	55	75	85	60	80	100	65	85	115
Tension load											
Displacement DLS	$\delta_{N,C2 (DLS)}$	[mm]	0,57			0,77			1,06		
Displacement ULS	$\delta_{N,C2 (ULS)}$	[mm]	2,08			2,78			3,89		
Shear load with Hilti filling set (HUS4-H and HUS4-A)											
Displacement DLS	$\delta_{V,C2 (DLS)}$	[mm]	4,07	1,80	4,05	1,73	4,00	2,52			
Displacement ULS	$\delta_{V,C2 (ULS)}$	[mm]	7,50	4,03	7,07	5,62	6,09	6,79			
Shear load without Hilti filling set											
Displacement DLS	$\delta_{V,C2 (DLS)}$	[mm]	4,07	4,15	4,05	4,90	4,00	4,93			
Displacement ULS	$\delta_{V,C2 (ULS)}$	[mm]	7,50	6,15	7,07	7,00	6,09	9,14			

Hilti screw anchor HUS4

Performances

Displacement values in case of seismic C2 loading

Annex C25

Table C23 continued

Fastener size HUS4			16			16
Type			H(F) G02			DW
			h_{nom1}	h_{nom2}	h_{nom3}	h_{nom}
Nominal embedment depth	h_{nom}	[mm]	85	110	130	130
Tension load						
Displacement DLS	$\delta_{N,C2 (DLS)}$	[mm]	1,56	1,68		
Displacement ULS	$\delta_{N,C2 (ULS)}$	[mm]	4,64	4,69		
Shear load with Hilti filling set						
Displacement DLS	$\delta_{V,C2 (DLS)}$	[mm]	5,84			
Displacement ULS	$\delta_{V,C2 (ULS)}$	[mm]	11,04			
Shear load without Hilti filling set						
Displacement DLS	$\delta_{V,C2 (DLS)}$	[mm]	5,84			
Displacement ULS	$\delta_{V,C2 (ULS)}$	[mm]	11,04			

Hilti screw anchor HUS4

Performances
Displacement values in case of seismic C2 loading

Annex C26

Eine vom Bund und den Ländern gemeinsam
getragene Anstalt des öffentlichen Rechts

Europäische Technische
Bewertungsstelle für Bauprodukte



Europäische Technische Bewertung

ETA-20/0867
vom 22. Dezember 2025

Allgemeiner Teil

Technische Bewertungsstelle, die die Europäische Technische Bewertung ausstellt

Handelsname des Bauprodukts

Produktfamilie,
zu der das Bauprodukt gehört

Hersteller

Herstellungsbetrieb

Diese Europäische Technische Bewertung enthält

Diese Europäische Technische Bewertung wird ausgestellt gemäß der Verordnung (EU) Nr. 305/2011, auf der Grundlage von

Diese Fassung ersetzt

Deutsches Institut für Bautechnik

Hilti Betonschraube HUS4

Mechanische Dübel zur Verwendung im Beton

Hilti AG

Feldkircherstraße 100

9494 Schaan

FÜRSTENTUM LIECHTENSTEIN

Hilti Werke

50 Seiten, davon 3 Anhänge, die fester Bestandteil dieser Bewertung sind.

EAD 330232-02-0601

ETA-20/0867 vom 13. Juni 2025

Die Europäische Technische Bewertung wird von der Technischen Bewertungsstelle in ihrer Amtssprache ausgestellt. Übersetzungen dieser Europäischen Technischen Bewertung in andere Sprachen müssen dem Original vollständig entsprechen und müssen als solche gekennzeichnet sein.

Diese Europäische Technische Bewertung darf, auch bei elektronischer Übermittlung, nur vollständig und ungekürzt wiedergegeben werden. Nur mit schriftlicher Zustimmung der ausstellenden Technischen Bewertungsstelle kann eine teilweise Wiedergabe erfolgen. Jede teilweise Wiedergabe ist als solche zu kennzeichnen.

Die ausstellende Technische Bewertungsstelle kann diese Europäische Technische Bewertung widerrufen, insbesondere nach Unterrichtung durch die Kommission gemäß Artikel 25 Absatz 3 der Verordnung (EU) Nr. 305/2011.

Besonderer Teil

1 Technische Beschreibung des Produkts

Die Hilti Betonschraube HUS4 ist ein Dübel in den Größen 8, 10, 12, 14 und 16 mm aus galvanisch verzinktem oder nichtrostendem Stahl. Der Dübel wird in ein vorgebohrtes zylindrisches Bohrloch geschraubt. Das Spezialgewinde schneidet während des Setzvorgangs ein Innengewinde in den Verankerungsgrund. Die Verankerung erfolgt durch Formschluss des Spezialgewindes.

Die Produktbeschreibung ist in Anhang A angegeben.

2 Spezifizierung des Verwendungszwecks gemäß dem anwendbaren Europäischen Bewertungsdokument

Von den Leistungen in Abschnitt 3 kann nur ausgegangen werden, wenn der Dübel entsprechend den Angaben und Bedingungen nach Anhang B verwendet wird.

Die Prüf- und Bewertungsmethoden, die dieser Europäischen Technischen Bewertung zu Grunde liegen, führen zur Annahme einer Nutzungsdauer des Dübels von mindestens 50 Jahren. Die Angabe der Nutzungsdauer kann nicht als Garantie des Herstellers verstanden werden, sondern ist lediglich ein Hilfsmittel zur Auswahl des richtigen Produkts in Bezug auf die angenommene wirtschaftlich angemessene Nutzungsdauer des Bauwerks.

3 Leistung des Produkts und Angabe der Methoden ihrer Bewertung

3.1 Mechanische Festigkeit und Standsicherheit (BWR 1)

Wesentliches Merkmal	Leistung
Charakteristischer Widerstand unter Zugbeanspruchung (statische und quasi-statische Einwirkungen)	Siehe Anhang B5 bis B9, Anhang C1, C3, C5 und C7
Charakteristischer Widerstand unter Querbeanspruchung (statische und quasi-statische Einwirkungen)	Siehe Anhang C2, C4, C6 und C7
Verschiebungen (statische und quasi-statische Einwirkungen)	Siehe Anhang C21 bis C23
Steifigkeit	Keine Leistung bewertet
Charakteristischer Widerstand und Verschiebungen für die seismischen Leistungskategorien C1 und C2	Siehe Anhang C8 bis C13 und C24

3.2 Brandschutz (BWR 2)

Wesentliches Merkmal	Leistung
Brandverhalten	Klasse A1
Feuerwiderstand	Siehe Anhang C14 bis C20

3.3 Aspekte der Dauerhaftigkeit in Bezug auf die Grundanforderungen an Bauwerke

Wesentliches Merkmal	Leistung
Dauerhaftigkeit	Siehe Anhang B1

4 Angewandtes System zur Bewertung und Überprüfung der Leistungsbeständigkeit mit der Angabe der Rechtsgrundlage

Gemäß dem Europäischen Bewertungsdokument EAD 330232-02-0601 gilt folgende Rechtsgrundlage: [96/582/EG].

Folgendes System ist anzuwenden: 1

5 Für die Durchführung des Systems zur Bewertung und Überprüfung der Leistungsbeständigkeit erforderliche technische Einzelheiten gemäß anwendbarem Europäischen Bewertungsdokument

Technische Einzelheiten, die für die Durchführung des Systems zur Bewertung und Überprüfung der Leistungsbeständigkeit notwendig sind, sind Bestandteil des Kontrollplans, der beim Deutschen Institut für Bautechnik hinterlegt ist.

Ausgestellt in Berlin am 22. Dezember 2025 vom Deutschen Institut für Bautechnik

Dipl.-Ing. Beatrix Wittstock
Referatsleiterin

Beglaubigt
Tempel

Einbauzustand ohne Adjustierung

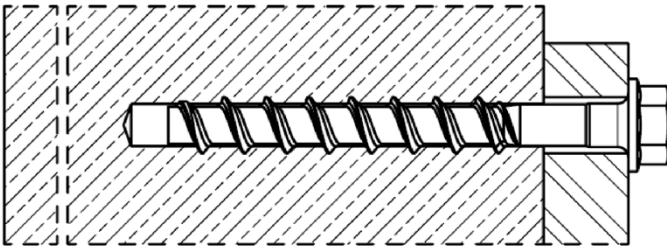

HUS4-H (Ausführung Sechskantkopf
Größen 8, 10, 12, 14 und 16)

HUS4 T-H (Ausführung Sechskantkopf
Größen 8 and 10)

HUS4-HF (Ausführung Sechskantkopf
Größen 8, 10, 12, 14 und 16)

HUS4 T-HF (Ausführung Sechskantkopf
Größen 8 and 10)

HUS4-HR (Ausführung Sechskantkopf
Größen 6, 8, 10 und 14)

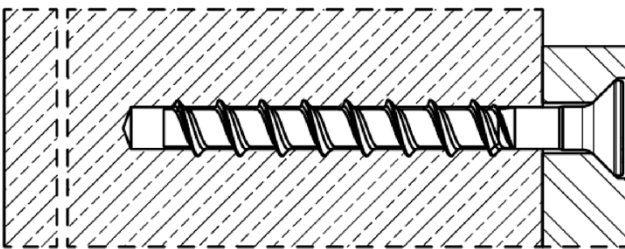

HUS4-C (Ausführung mit Senkkopf
Größen 8 and 10)

HUS4 T-C (Ausführung mit Senkkopf
Größen 8 and 10)

HUS4-CR (Ausführung mit Senkkopf
Größen 6, 8, 10 und 14)

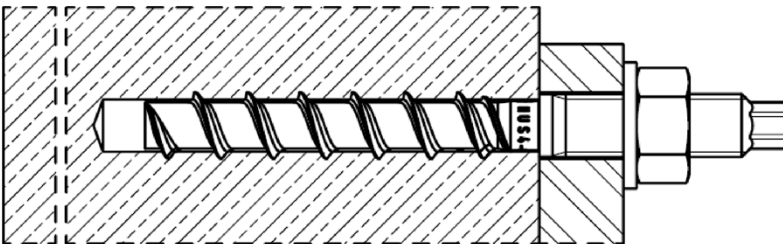

HUS4-A

(Ausführung Außengewinde
Größe 10 mit M12 und Größe 14 mit M16)

HUS4-AF

(Ausführung Außengewinde
Größe 10 mit M12 und Größe 14 mit M16)

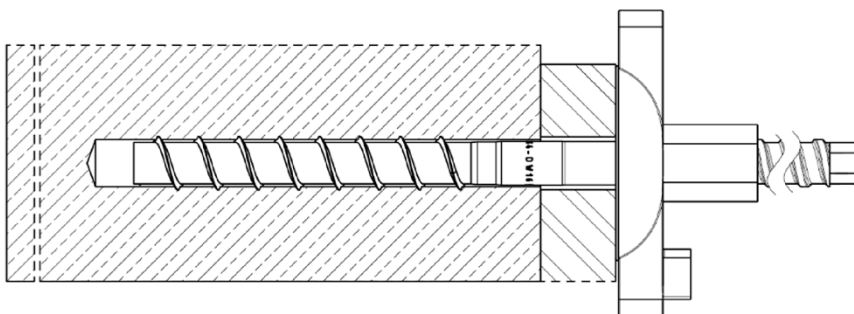

HUS4-DW

(trapezoidal threaded rod
connection, size 16)

Hilti Betonschraube HUS4

Produktbeschreibung
Einbauzustand ohne Adjustierung

Anhang A1

Einbauzustand mit Adjustierung

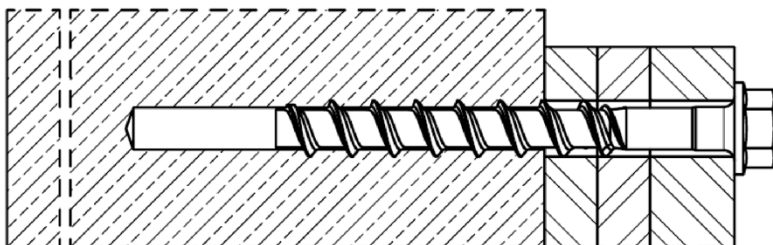

HUS4-H (Ausführung Sechskantkopf
Größen 8, 10, 12, 14 and 16 G02)
HUS4 T-H (Ausführung Sechskantkopf
Größen 8 and 10)
HUS4-HF (Ausführung Sechskantkopf
Größen 8, 10, 12, 14 and 16 G02)
HUS4 T-HF (Ausführung Sechskantkopf
Größen 8 and 10)

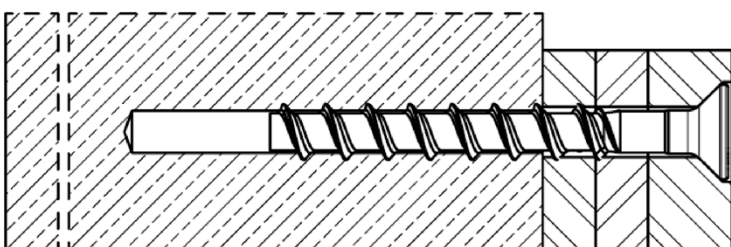

HUS4-C (Ausführung mit Senkkopf
Größen 8 and 10)
HUS4 T-C (Ausführung mit Senkkopf
Größen 8 and 10)

Hilti Betonschraube HUS4

Produktbeschreibung
Einbauzustand mit Adjustierung

Anhang A2

Tabelle A1: Schraubenausführungen

Hilti HUS4-H, Größe 8, 10, 12, 14 und 16, Ausführung mit Sechskantkopf, Kohlenstoffstahl galvanisch verzinkt
Hilti HUS4-HF, Größe 8, 10, 12, 14 und 16, Ausführung mit Sechskantkopf, Kohlenstoffstahl mehrlagige Beschichtung

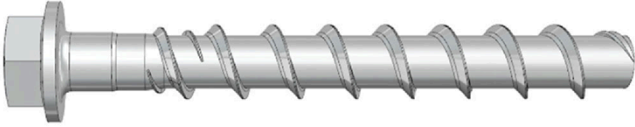

Hilti HUS4 T-H, Größe 8 und 10, Ausführung mit Sechskantkopf, Kohlenstoffstahl galvanisch verzinkt
Hilti HUS4 T-HF, Größe 8 und 10, Ausführung mit Sechskantkopf, Kohlenstoffstahl mehrlagige Beschichtung

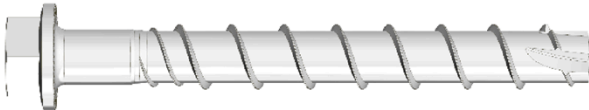

Hilti HUS4-HR, Größen 6, 8, 10 und 14, Ausführung mit Sechskantkopf, nichtrostender Stahl

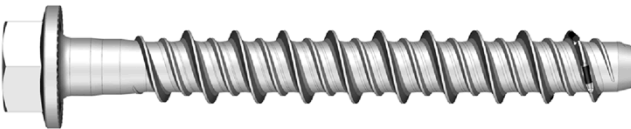

Hilti HUS4-C, Größe 8 und 10, Ausführung mit Senkkopf, Kohlenstoffstahl galvanisch verzinkt

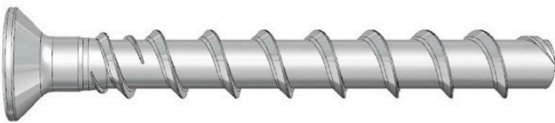

Hilti HUS4 T-C, Größe 8 und 10, Ausführung mit Senkkopf, Kohlenstoffstahl galvanisch verzinkt

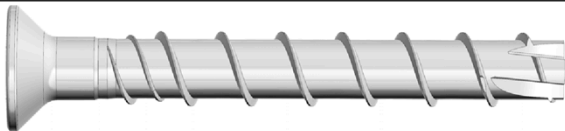

Hilti HUS4-CR, Größe 6, 8 und 10, Ausführung mit Senkkopf, nichtrostender Stahl



Hilti HUS4-A, Größe 10 mit Außengewinde M12 und Größe 14 mit Außengewinde M16, Kohlenstoffstahl galvanisch verzinkt
Hilti HUS4-AF, Größe 10 mit Außengewinde M12 und Größe 14 mit Außengewinde M16, Kohlenstoffstahl mehrlagige Beschichtung



Hilti HUS4-DW, Größe 16 Außengtrapezgewinde galvanisch verzinkt, Kohlenstoffstahl galvanisch verzinkt



Hilti Betonschraube HUS4



Produktbeschreibung
HUS4 Schraubenausführungen

Anhang A3

Tabelle A2: Materialien

Teil	Material
HUS4-H(F), HUS4-C and HUS4-A(F) Betonschraube	Kohlenstoffstahl, galvanisch verzinkt Bruchdehnung $A_5 \leq 8\%$
HUS4-HR und HUS4-CR Betonschraube	Nichtrostender Stahl (Klasse A4) nach EN 10088-1:2014 Bruchdehnung $A_5 > 8\%$ Korrosionswiderstandsklasse CRC III nach EN 1993-1-4:2006+A1:2015
Hilti Verfüll-Set (Kohlenstoffstahl)	Kohlenstoffstahl, galvanisch verzinkt
Hilti Verfüll-Set (Nichtrostender Stahl)	Nichtrostender Stahl (Klasse A4) nach EN 10088-1:2014 Korrosionswiderstandsklasse CRC III nach EN 1993-1-4:2006+A1:2015
Injektionsmörtel (für den Verfüll-Set)	Hilti HIT-HY... oder Hilti HIT-RE... (mit ETA)

Tabelle A3: Abmessungen und Kompatibilität des Verfüll-Sets

Größe Verfüll-Set		M10	M12	M16	M20
Durchmesser der Verschlusscheibe	d_{vs} [mm]	42	44	52	60
Dicke der Verschlusscheibe	h_{vs} [mm]	5	5	6	6
Dicke des Verfüll-Set	h_{fs} [mm]	9	10	11	13
Grösse HUS4 (T)-H (F, R)		8	10	12 + 14	16
Grösse HUS4-A (F)		-	10	14	-

Verschlusscheibe

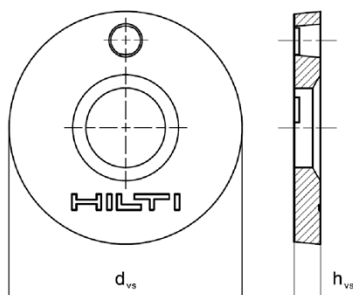

Kugelscheibe

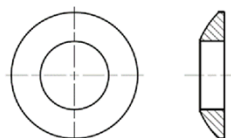

Verfüll-Set

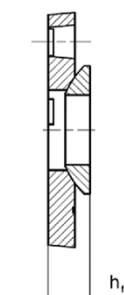



Hilti Betonschraube HUS4

Produktbeschreibung
Materialien

Anhang A4

Tabelle A4: Abmessungen und Markierung HUS4-A(F)

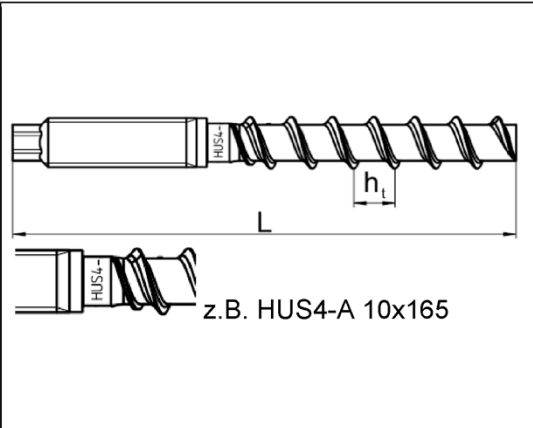
Größe HUS4-			A(F) 10			A(F) 14		
Nomineller Dübeldurchmesser	d	[mm]	10			14		
Außengewindeanschluss			M12			M16		
Gewindesteigung	h_t	[mm]	10			14		
Länge des Dübels im Beton	h_{nom}	[mm]	h_{nom1}	h_{nom2}	h_{nom3}	h_{nom1}	h_{nom2}	h_{nom3}
			55	75	85	65	85	115
Effektive Verankerungstiefe	h_{ef}	[mm]	$h_{ef} = 0,85 * (h_{nom} - 5) \leq h_{ef,max}$			$h_{ef} = 0,85 * (h_{nom} - 7) \leq h_{ef,max}$		
Grenze der effektiven Verankerungstiefe	$h_{ef,max}$	[mm]	68,0			91,8		
Länge der Schraube min / max	L	[mm]	120 / 165			155 / 205		

		HUS4: Hilti Universal Schraube 4. Generation
		A: Außengewinde, galvanisch verzinkt
		AF: Außengewinde, mehrlagige Beschichtung
		10: Nomineller Schraubendurchmesser d [mm]
		165: Länge der Schraube L [mm]
		8: C-Stahl
		K: Längenidentifikation HUS4-A 10x165
		G I K J L N
		10x120 10x140 10x165 14x155 14x185 14x205

Hilti Betonschraube HUS4

Produktbeschreibung
Abmessungen und Markierung

Anhang A5

Tabelle A5: Abmessungen und Kopfmarkierung HUS4 (T)-H(F)

Größe HUS4	H(F) 8			T-H(F) 8			H(F) 10			T-H(F) 10		
Nomineller Dübeldurchmesser d [mm]	8			8			10			10		
Gewindesteigung h _t [mm]	8			8			10			10		
Länge des Dübels im Beton h _{nom} [mm]	h _{nom1}	h _{nom2}	h _{nom3}	h _{nom1}	h _{nom2}	h _{nom3}	h _{nom1}	h _{nom2}	h _{nom3}	h _{nom1}	h _{nom2}	h _{nom3}
	40	60	70	50	60	70	55	75	85	55	75	85
Effektive Verankerungstiefe h _{ef} [mm]	$0,85 * (h_{nom} - 4,0) \leq h_{ef,max}$			$0,85 * (h_{nom} - 5,45) \leq h_{ef,max}$			$0,85 * (h_{nom} - 5,0) \leq h_{ef,max}$			$0,85 * (h_{nom} - 6,1) \leq h_{ef,max}$		
Grenze der effektiven Verankerungstiefe h _{ef,max} [mm]	56,1			54,9			68,0			67,1		
Länge der Schraube min / max L [mm]	45 / 150			55 / 150			60 / 305			60 / 150		

Größe HUS4-	H(F) 12			H(F) 14			H(F) 16		H(F) 16 G02		
Nomineller Dübeldurchmesser d [mm]	12			14			16		16		
Gewindesteigung h _t [mm]	12			14			13,2		14,5		
Länge des Dübels im Beton h _{nom} [mm]	h _{nom1}	h _{nom2}	h _{nom3}	h _{nom1}	h _{nom2}	h _{nom3}	h _{nom1}	h _{nom2}	h _{nom1}	h _{nom2}	h _{nom3}
	60	80	100	65	85	115	85	130	85	110	130
Effektive Verankerungstiefe h _{ef} [mm]	$h_{ef} = 0,85 * (h_{nom} - 6,0) \leq h_{ef,max}$			$h_{ef} = 0,85 * (h_{nom} - 7,0) \leq h_{ef,max}$			$h_{ef} = 0,85 * (h_{nom} - 6,6) \leq h_{ef,max}$		$0,85 * (h_{nom} - 7,2) \leq h_{ef,max}$		
Grenze der effektiven Verankerungstiefe h _{ef,max} [mm]	79,9			91,8			104,9		104,3		
Länge der Schraube min / max L [mm]	70 / 150			75 / 150			100 / 205		100 / 205		

Hilti Betonschraube HUS4

Produktbeschreibung
Abmessungen und Markierung

Anhang A6

Tabelle A6: Abmessungen und Kopfmarkierung HUS4-HR

Größe HUS4-	HR 6	HR 8	HR 10	HR 14		
Nomineller Dübeldurchmesser d [mm]	6	8	10	14		
Gewindesteigung h_t [mm]	4,75	7,6	8,0	9,8		
Nicht tragende Spitze h_s [mm]	-	1,03	2,43	4,1		
Länge des Dübels im Beton h_{nom} [mm]	h_{nom2}	h_{nom2}	h_{nom3}	h_{nom2}	h_{nom3}	
	55	60	80	70	90	70
Effektive Verankerungstiefe h_{ef} [mm]	$0,85 * (h_{nom} - 2,37) \leq h_{ef,max}$	$0,85 * (h_{nom} - 4,8) \leq h_{ef,max}$	$0,85 * (h_{nom} - 6,4) \leq h_{ef,max}$	$0,85 * (h_{nom} - 9,0) \leq h_{ef,max}$		
Grenze der effektiven Verankerungstiefe $h_{ef,max}$ [mm]	45	64	71	86		
Länge der Schraube min / max L [mm]	60 / 70	65 / 105	75 / 130	80 / 135		

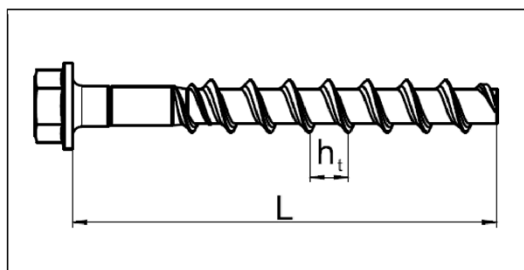

HUS4: Hilti Universal Schraube 4. Generation

(T-)H: Sechskantkopf, galvanisch verzinkt

(T-)HF: Sechskantkopf, mehrlagige Beschichtung

HR: Sechskantkopf, nichtrostender Stahl

10: Nomineller Schraubendurchmesser d [mm]

100: Länge der Schraube [mm]

Hilti Betonschraube HUS4



Produktbeschreibung
Abmessungen und Markierung

Anhang A7

Tabelle A7: Abmessungen und Kopfmarkierung HUS4 (T)-C(R)

Größe HUS4-			C 8			T-C 8			C 10			T-C 10		
Nomineller Dübeldurchmesser	d	[mm]	8			8			10			10		
Gewindesteigung	h_t	[mm]	8			8			10			10		
Länge des Dübels im Beton	h_{nom}	[mm]	h_{nom1}	h_{nom2}	h_{nom3}	h_{nom1}	h_{nom2}	h_{nom3}	h_{nom1}	h_{nom2}	h_{nom3}	h_{nom1}	h_{nom2}	h_{nom3}
			40	60	70	50	60	70	55	75	85	55	75	85
Effektive Verankerungstiefe	h_{ef}	[mm]	$0,85 * (h_{nom} - 4) \leq h_{ef,max}$			$0,85 * (h_{nom} - 5,45) \leq h_{ef,max}$			$0,85 * (h_{nom} - 5) \leq h_{ef,max}$			$0,85 * (h_{nom} - 6,1) \leq h_{ef,max}$		
Grenze der effektiven Verankerungstiefe	$h_{ef,max}$	[mm]	56,1			54,9			68,0			67,1		
Länge der Schraube min / max	L	[mm]	55 / 160			65 / 85			70 / 180			70 / 305		

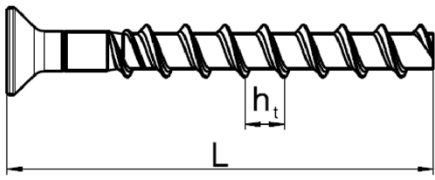
Größe HUS4-			CR 6		CR 8		CR 10	
Nomineller Dübeldurchmesser	d	[mm]	6		8		10	
Gewindesteigung	h_t	[mm]	4,75		7,6		8,0	
Nicht tragende Spitze Länge des Dübels im Beton	h_{nom}	[mm]	h_{nom2}		h_{nom2}	h_{nom3}	h_{nom2}	h_{nom3}
			55		60	80	70	90
Effective embedment depth	h_{ef}	[mm]	$0,85 * (h_{nom} - 2,37) \leq h_{ef,max}$		$0,85 * (h_{nom} - 4,8) \leq h_{ef,max}$		$0,85 * (h_{nom} - 6,4) \leq h_{ef,max}$	
Effektive Verankerungstiefe	$h_{ef,max}$	[mm]	45		64		71	
Grenze der effektiven Verankerungstiefe	L	[mm]	60 / 70		65 / 95		75 / 105	

		HUS4: Hilti Universal Schraube 4. Generation
		(T-)C: Senkkopf, galvanisch verzinkt
		CR: Senkkopf, nichtrostender Stahl
		10: Nomineller Schraubendurchmesser d [mm]
		100: Länge der Schraube L [mm]

Hilti Betonschraube HUS4

Produktbeschreibung
Abmessungen und Kopfmarkierung

Anhang A8

Tabelle A8: Abmessungen und Kopfmarkierung HUS4-DW

Größe HUS4-			DW 16
Nomineller Dübeldurchmesser	d	[mm]	16
Gewindesteigung	h_t	[mm]	14,5
Länge des Dübels im Beton	h_{nom}	[mm]	h_{nom}
			130
Effektive Verankerungstiefe	h_{ef}	[mm]	$0,85 * (h_{nom} - 7,2) \leq h_{ef,max}$
Grenze der effektiven Verankerungstiefe	$h_{ef,max}$	[mm]	104,3
Länge der Schraube min / max	L	[mm]	458 / 858

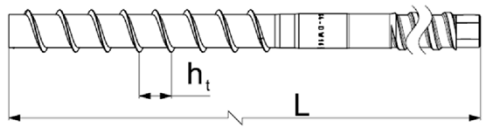
	HUS4: Hilti Universal Screw 4 th generation
	DW: Außengrauzgewinde galvanisch verzinkt
	16: Nomineller Schraubendurchmesser d [mm]
	458: Länge der Schraube L [mm]

Hilti Betonschraube HUS4

Produktbeschreibung
Abmessungen und Kopfmarkierung

Anhang A9

Spezifizierung des Verwendungszwecks

Beanspruchung der Verankerung:

- Statische und quasi-statische Belastung
- Seismische Einwirkung C1 und C2 für HUS4 (T)-H(F)/-C/-A(F) (Kohlenstoffstahl)
- Seismische Einwirkung C1: HUS4-HR/-CR Größe 8, 10 and 14, (nichtrostender Stahl)
- Brandbeanspruchung

Verankerungsgrund:

- Verdichteter bewehrter oder unbewehrter Normalbeton ohne Fasern gemäß EN 206:2013+A1:2016.
- Festigkeitsklasse C20/25 bis C50/60 entsprechend EN 206:2013+A1:2016.
- Gerissener oder ungerissener Beton.
- Die Verankerung darf in Stahlfaserbeton (SFRC) nach EN 206:2013+A2:2021 angewendet werden. Die Stahlfasern müssen EN 14889-1:2006, Abschnitt 5, Gruppe I entsprechen. Der Fasergehalt darf maximal 80 kg/m³ betragen.

Anwendungsbedingungen (Umweltbedingungen):

- Bauteile unter den Bedingungen trockener Innenräume.
- Für alle anderen Bedingungen entsprechend der Korrosionswiderstandsklasse CRC nach EN 1993-1-4:2006+A1:2015
 - Nichtrostender Stahl nach Anhang A3, Tabelle A2, Schraubenarten HUS4-HR/-CR: CRC III

Bemessung:

- Die Befestigungen müssen unter der Verantwortung eines auf dem Gebiet der Verankerungen und des Betonbaus erfahrenen Ingenieurs bemessen werden.
- Unter Berücksichtigung der zu verankernden Lasten sind prüfbare Berechnungen und Konstruktionszeichnungen anzufertigen. Auf den Konstruktionszeichnungen ist die Lage des Dübels (z. B. Lage des Dübels zur Bewehrung oder zu den Auflagern usw.) anzugeben.
- Die Bemessung der Verankerungen erfolgt in Übereinstimmung mit:
EN 1992-4:2018 und EOTA Technical Report TR 055, Fassung Februar 2018
- Bei Anforderungen an den Brandschutz ist sicherzustellen, dass lokale Betonabplatzungen vermieden werden.
- Die Bemessung erfolgt in Stahlfaserbeton (SFRC) nach EN 1992-4:2018 mit den wesentlichen Merkmalen wie sie für Normalbeton der Festigkeitsklasse C20/25 bis C50/60 ohne Fasern angegeben sind.

Einbau:

- Der Verankerung durch entsprechend geschulten Personals und unter der Aufsicht des Bauleiters.
- Bei Fehlbohrungen: Anordnung eines neuen Bohrlochs in einem Abstand, der mindestens der doppelten Tiefe der Fehlbohrung entspricht, oder in geringerem Abstand, wenn die Fehlbohrung mit hochfestem Mörtel verfüllt wird und wenn sie bei Quer- oder Schrägzuglast nicht in Richtung der aufgetragenen Last liegt.
- Nach der Montage darf ein leichtes Weiterdrehen des Dübels nicht möglich sein.
- Der Dübelkopf (HUS4 (T)-H (F, R) und HUS4 (T)-C/-CR) muss am Anbauteil anliegen und darf nicht beschädigt sein.
- Das Hilti Verfüll-Set darf mit HUS4 (T)-H (F, R) und HUS4-A (F) verwendet werden.

Hilti Betonschraube HUS4

Verwendungszweck
Spezifikationen

Anhang B1

Spezifizierung des Verwendungszwecks: Bohren und reinigen für Kohlenstoffstahl

Adjustierung gemäß Anhang B11 ist für HUS4 Schrauben aus Kohlenstoffstahl in den Größen 8 and 10 bei h_{nom2+3} , sowie für Größen 12, 14 und 16 G02 bei allen h_{nom} möglich.

Tabelle B1: Statische und quasi-statische Lasten für HUS4 (T)-H(F)/-C/-A(F)



HUS4 (T)-H(F)/-C/-A(F)		Dübelgröße und Einbindetiefe h_{nom}
Gerissener und ungerissener Beton		
Hammerbohren (HD) ¹⁾	gereinigt 	Größe 8 bis 16 mit allen h_{nom}
	ungereinigt	Größe 8 bis 14 und 16 G02 mit allen h_{nom}
Hammerbohren mit Hilti Hohlbohrern TE-CD (HDB) ¹⁾ 		Größe 12 und 14 mit allen h_{nom}
Ungerissener Beton		
Diamantbohren (DD) DD30-W handgeführt und with Bohrständer  DD-EC1 handgeführt		Größe 10 bis 14 mit h_{nom3} (ausgenommen HUS4 T)

Tabelle B2: Seismische Einwirkung Kategorie C1 für HUS4 (T)-H(F)/-C/-A(F)



HUS4 (T)-H(F)/-C/-A(F)		Dübelgröße und Einbindetiefe h_{nom}
Hammerbohren (HD) ¹⁾	gereinigt 	Größe 8 bis 16 mit allen h_{nom} (ausgenommen HUS4 8 mit h_{nom1})
	ungereinigt	Größe 8 bis 14, 16 G02 und 16 DW mit allen h_{nom} (ausgenommen HUS4 8 mit h_{nom1})
Hammerbohren mit Hilti Hohlbohrern TE-CD (HDB) ¹⁾ 		Größe 12 und 14 mit allen h_{nom}

Tabelle B3: Seismische Einwirkung Kategorie C2 für HUS4 (T)-H(F)/-C/-A(F)



HUS4 (T)-H(F)/-C/-A(F)		Dübelgröße und Einbindetiefe h_{nom}
Hammerbohren (HD) ¹⁾	Gereinigt und ungereinigt 	Größe 8 bis 14, 16 G02 und 16 DW mit alle h_{nom} (ausgenommen HUS4 8 mit h_{nom1})

Tabelle B4: Statische und quasi-statische Lasten unter Brandbeanspruchung für HUS4 (T)-H(F)/-C/-A(F)



HUS4 (T)-H(F)/-C/-A(F)		Dübelgröße und Einbindetiefe h_{nom}
Hammerbohren (HD) ¹⁾	gereinigt 	Größe 8 bis 16 mit allen h_{nom}
	ungereinigt	Größe 8 bis 14 und 16 G02 mit allen h_{nom}
Hammerbohren mit Hilti Hohlbohrern TE-CD (HDB) ¹⁾ 		Größe 12 und 14 mit allen h_{nom}

Hilti Betonschraube HUS4

Verwendungszweck
Spezifikationen

Anhang B2

**Table B5: Verwendung in Stahlfaserbeton (SFRC) für HUS4 (T)-H(F)/-C/-A(F)
(Ausgenommen seismische Kategorie C2)**

HUS4 (T)-H(F)/-C/-A(F)		Fastener size and embedment depth h_{nom}
Gerissener und ungerissener Beton		
Hammerbohren (HD) ¹⁾	gereinigt 	Größe 8 bis 16 mit allen h_{nom}
	ungereinigt	Größe 8 bis 14 und 16 G02 mit allen h_{nom}
Hammer drilling with Hilti hollow drill bit TE-CD (HDB) ¹⁾ 		Größe 12 und 14 mit allen h_{nom}
Ungerissener Beton		
Diamantbohren (DD) DD30-W handgeführt und with Bohrständer  DD-EC1 handgeführt		Größe 10 bis 14 mit h_{nom3} (Ausgenommen HUS4 T)

Spezifizierung des Verwendungszwecks: Bohren und reinigen für HUS4 nichtrostender Stahl

Adjustierung gemäß Anhang B11 ist für HUS4 Schrauben aus nichtrostender Stahl nicht möglich.

Tabelle B6: Statische und quasi-statische Lasten für HUS4-HR/-CR

HUS4-HR/-CR		Dübelgröße und Einbindetiefe h_{nom}
Gerissener und ungerissener Beton		
Hammerbohren (HD)	gereinigt 	Größe 6 bis 14 mit allen h_{nom}
	ungereinigt	

Tabelle B7: Seismische Einwirkung C1 für HUS4-HR/-CR



HUS4-HR/-CR		Dübelgröße und Einbindetiefe h_{nom}
Hammerbohren (HD)	gereinigt 	Größe 8 bis 14 mit h_{nom2}
	ungereinigt	Größe 8 bis 14 mit h_{nom2}

Tabelle B8: Statische und quasi-statische Lasten unter Brandbeanspruchung für HUS4-HR/-CR

HUS4-HR/-CR		Dübelgröße und Einbindetiefe h_{nom}
Hammerbohren (HD)	gereinigt 	Größe 6 bis 14 mit allen h_{nom}
	ungereinigt	Größe 6 bis 14 mit allen h_{nom}

Hilti Betonschraube HUS4

Verwendungszweck
Spezifikationen

Anhang B3

Montagekennwerte

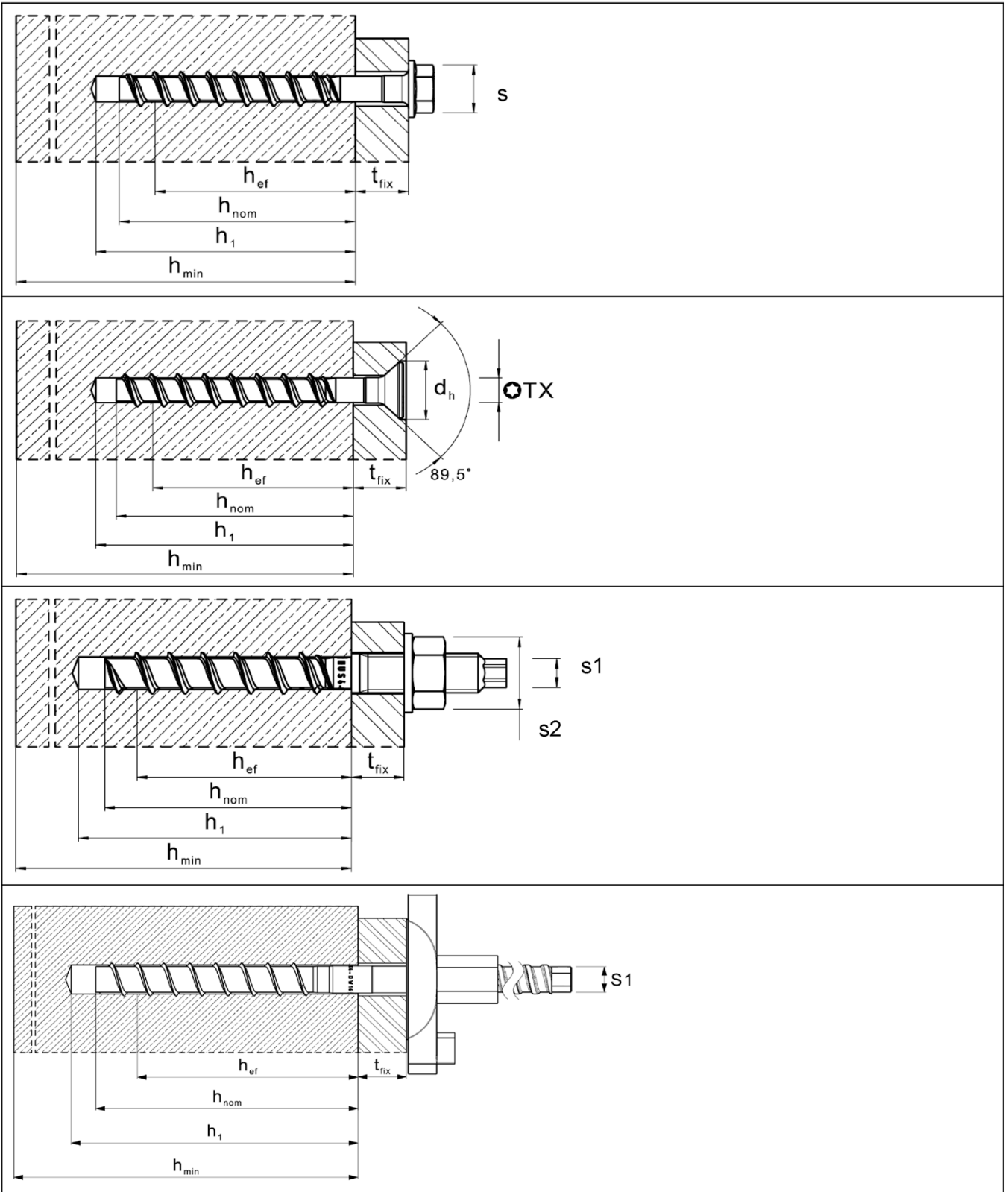

Hilti Betonschraube HUS4

Verwendungszweck
Montagekennwerte

Anhang B4

Tabelle B9: Montagekennwerte HUS4 8 und 10

Größe HUS4 Typ	8 H(F), C			8 T-H(F), T-C			10 H(F), C, A(F)					
	h_{nom1}	h_{nom2}	h_{nom3}	h_{nom1}	h_{nom2}	h_{nom3}	h_{nom1}	h_{nom2}	h_{nom3}			
Länge des Dübels im Beton	h_{nom}	[mm]	40	60	70	50	60	70	55	75	85	
Bohrerinnendurchmesser	d_0	[mm]	8			8			10			
Bohrerschneidendurchmesser	$d_{cut} \leq$	[mm]	8,45			8,45			10,45			
Durchmesser der Diamantbohrkrone	$d_{cut} \leq$	[mm]	-			-			9,9			
Durchgangsloch im Anbauteil Durchsteckmontage	d_f	$\frac{min}{max}$	[mm]	11			11			13		
				12			12			14		
Durchgangsloch im Anbauteil Vorsteckmontage (A-Typ)	$d_f \leq$	[mm]	-			-			14			
Schlüsselweite (H, HF- Typ)	s	[mm]	13			13			15			
Schlüsselweite für den Sechskantkopf (A-Typ)	s1	[mm]	-			-			8			
Schlüsselweite für die Mutter (A- Typ)	s2	[mm]	-			-			19			
Maximales Anziehdrehmoment (A- Typ)	$max T_{inst}$	[Nm]	-			-			40			
Torx-Größe (C-Typ)	TX	-	45			45			50			
Durchmesser Senkkopf	d_h	[mm]	18			18			21			
Bohrlochtiefe für gereinigte Bohrlöcher Hammerbohren, Diamantbohren oder ungereinigt Hammerbohren Überkopf	$h_1 \geq$	[mm]	$(h_{nom} + 10 \text{ mm})$									
			50	70	80	60	70	80	65	85	95	
Bohrlochtiefe für ungereinigte Bohrlöcher Hammerbohren in Wand und Bodenposition	$h_1 \geq$	[mm]	$h_{nom} + 25$						$h_{nom} + 30$			
			65	85	95	75	85	95	85	105	115	
Bohrlochtiefe (mit Adjustierung) für gereinigte Bohrlöcher. Hammerbohren, Diamantbohren oder ungereinigt Hammerbohren Überkopf	$h_1 \geq$	[mm]	$h_{nom} + 20 \text{ mm}$									
			-	80	90	70	80	90	-	95	105	
Bohrlochtiefe (mit Adjustierung) für ungereinigte Bohrlöcher Hammerbohren in Wand und Bodenposition	$h_1 \geq$	[mm]	$h_{nom} + 35$						$h_{nom} + 40$			
			-	95	105	85	95	105	-	115	125	
Minimale Dicke des Betonbauteils	$h_{min} \geq$	[mm]	$h_1 + 30 \text{ mm}$									
			80	100	120	100	100	120	100	130	140	
Minimaler Achsabstand	$s_{min} \geq$	[mm]	35			50 ²⁾	50	50	40			
Minimaler Randabstand	$c_{min} \geq$	[mm]	35			40	40	40	40			
Hilti Setzgerät ¹⁾	SIW 4(AT)-22 SIW 6(AT)-A22 SIW 6(AT)-22 gear 1 SI-AT-22 Modul optional						SIW 6(AT)-22 SIW 22T-A SIW 8-22 gear 1 SIW 9-A22 SI-AT-22 Modul optional					

¹⁾ Installation mit anderem Tangential-Schlagschrauber bei gleichwertiger Leistung ist zulässig.

²⁾ $s_{min} = 40 \text{ mm}$ möglich, wenn $c_{min} \geq 50 \text{ mm}$.

Hilti Betonschraube HUS4

Verwendungszweck
Montagekennwerte

Anhang B5

Tabelle B10: Montagekennwerte HUS4 10 bis 14

Größe HUS4 Typ	10			12			14		
	T-H(F), T-C			H(F)			H(F), A(F)		
	h_{nom1}	h_{nom2}	h_{nom3}	h_{nom1}	h_{nom2}	h_{nom3}	h_{nom1}	h_{nom2}	h_{nom3}
Länge des Dübels im Beton h_{nom} [mm]	55	75	85	60	80	100	65	85	115
Bohrernenndurchmesser d_0 [mm]	10			12			14		
Bohrerschneidendurchmesser $d_{cut} \leq$ [mm]	10,45			12,50			14,50		
Durchmesser der Diamantbohrkrone $d_{cut} \leq$ [mm]	-			12,2			14,2		
Durchgangsloch im Anbauteil Durchsteckmontage $d_f \frac{\min}{\max}$ [mm]	14			16			18		
Durchgangsloch im Anbauteil Durchsteckmontage $d_f \leq$ [mm]	-			-			18		
Schlüsselweite (H, HF- Typ) s [mm]	15			17			21		
Schlüsselweite für den Sechskantkopf (A-Typ) s_1 [mm]	-			-			12		
Schlüsselweite für die Mutter (A-Typ) s_2 [mm]	-			-			24		
Maximales Anziehdrehmoment (A-Typ) $\max T_{inst}$ [Nm]	-			-			80		
Torx-Größe (C-Typ) TX -	50			-			-		
Durchmesser Senkkopf d_h [mm]	21			-			-		
Bohrlochtiefe für gereinigte Bohrlöcher Hammerbohren, Diamantbohren oder ungereinigt Hammerbohren Überkopf $h_1 \geq$ [mm]	$h_{nom} + 10 \text{ mm}$								
	65	85	95	70	90	110	75	95	125
Bohrlochtiefe für ungereinigte Bohrlöcher Hammerbohren in Wand und Bodenposition $h_1 \geq$ [mm]	$h_{nom} + 30$			$h_{nom} + 35$			$h_{nom} + 40$		
	85	105	115	95	115	135	105	125	155
Bohrlochtiefe (mit Adjustierung) für gereinigte Bohrlöcher. Hammerbohren, Diamantbohren, oder ungereinigt Hammerbohren Überkopf $h_1 \geq$ [mm]	$h_{nom} + 20 \text{ mm}$								
	75	95	105	80	100	120	85	105	135
Bohrlochtiefe (mit Adjustierung) für ungereinigte Bohrlöcher Hammerbohren in Wand und Bodenposition $h_1 \geq$ [mm]	$h_{nom} + 40$			$h_{nom} + 45$			$h_{nom} + 50$		
	95	115	125	105	125	145	115	135	165
Minimale Dicke des Betonbauteils $h_{min} \geq$ [mm]	$h_1 + 30 \text{ mm}$								
	100	130	140	110	130	150	120	160	200
Minimaler Achsabstand $s_{min} \geq$ [mm]	50			50			60		
Minimaler Randabstand $c_{min} \geq$ [mm]	50			50			60		
Hilti Setzgerät ¹⁾	SIW 6(AT)-22 SIW 22T-A SIW 8-22 Gang 1 SIW 9-A22 SI-AT-22 Modul optional			SIW 6(AT)-22 SIW 22T-A SIW 8-22 SIW 9-A22 SI-AT-22 Modul optional					

¹⁾ Installation mit anderem Tangential-Schlagschrauber bei gleichwertiger Leistung ist zulässig.

Hilti Betonschraube HUS4

Verwendungszweck
Montagekennwerte

Anhang B6

Tabelle B11: Montagekennwerte HUS4-16

Größe HUS4 Typ		16 H(F)		16 H(F) G02			16 DW
		h_{nom1}	h_{nom2}	h_{nom1}	h_{nom2}	h_{nom3}	h_{nom3}
Länge des Dübels im Beton	h_{nom} [mm]	85	130	85	110	130	130
Bohrernennendurchmesser	d_0 [mm]	16		16			16
Bohrerschneidendurchmesser	$d_{cut} \leq$ [mm]	16,50		16,50			16,50
Durchgangsloch im Anbauteil Durchsteckmontage	$d_f \leq$ [mm]	20		20			20
Durchgangsloch im Anbauteil Durchsteckmontage (DW- Typ)	$d_f \leq$ [mm]	-		-			20
Schlüsselweite (H, HF- Typ)	s [mm]	24		24			-
Schlüsselweite für den Sechskantkopf (DW-Typ)	s_1 [mm]	-		-			13
Bohrlochtiefe für gereinigte Bohrlöcher Hammerbohren, Diamantbohren oder ungereinigt Hammerbohren Überkopf	$h_1 \geq$ [mm]	$h_{nom} + 10$ mm					
		95	140	95	120	140	140
Bohrlochtiefe für ungereinigte Bohrlöcher Hammerbohren in Wand und Bodenposition	$h_1 \geq$ [mm]	-		$h_{nom} + 40$ mm			
		-	-	125	150	170	170
Bohrlochtiefe (mit Adjustierung) für gereinigte Bohrlöcher. Hammerbohren, Diamantbohren, oder ungereinigt Hammerbohren Überkopf	$h_1 \geq$ [mm]	-		$h_{nom} + 20$ mm			
		-	-	105	130	150	150
Bohrlochtiefe (mit Adjustierung) für ungereinigte Bohrlöcher Hammerbohren in Wand und Bodenposition	$h_1 \geq$ [mm]	-		$h_{nom} + 50$ mm			
		-	-	135	160	180	180
Minimale Dicke des Betonbauteils	$h_{min} \geq$ [mm]	$h_1 + 35$ mm					
		130	195	130	155	175	175
Minimaler Achsabstand	$s_{min} \geq$ [mm]	90		70			
Minimaler Randabstand	$c_{min} \geq$ [mm]	65		65			
Hilti Setzgerät ¹⁾		SIW 22T-A SIW 6(AT)-22 SIW 8-22 SIW 9-A22 SIW 10-22 SI-AT-22 module optional					SIW 22T-A SIW 6(AT)-22 SIW 8-22 SIW 9-A22 SIW 10-22

¹⁾ Installation mit anderem Tangential-Schlagschrauber bei gleichwertiger Leistung ist zulässig.

Hilti Betonschraube HUS4

Verwendungszweck
Montagekennwerte

Anhang B7

Tabelle B12: Montagekennwerte HUS4-HR/-CR 6 und 8

Größe HUS4		6	8	
Typ		HR, CR	HR, CR	
		h_{nom1}	h_{nom1}	h_{nom2}
Länge des Dübels im Beton	h_{nom} [mm]	55	60	80
Bohrernennendurchmesser	d_0 [mm]	6	8	
Bohrerschneidendurchmesser	$d_{cut} \leq$ [mm]	6,40	8,45	
Durchgangsloch im Anbauteil Durchsteckmontage	$d_f \leq$ [mm]	9	12	
Schlüsselweite (H-Typ)	s [mm]	13	13	
Torx-Größe (C-Typ)	TX [-]	30	45	
Durchmesser Senkkopf	d_h [mm]	11	18	
Bohrlochtiefe für gereinigte Bohrlöcher Hammerbohren oder ungereinigt Hammerbohren Überkopf	$h_1 \geq$ [mm]	$h_{nom} + 10\text{mm}$		
		65	70	90
Bohrlochtiefe für ungereinigte Bohrlöcher Hammerbohren in Wand und Bodenposition	$h_1 \geq$ [mm]	$h_{nom} + 20\text{ mm}$		
		75	85	75
Minimale Dicke des Betonbauteils	$h_{min} \geq$ [mm]	$h_1 + 30\text{ mm}$		
		100	100	120
Minimaler Achsabstand	$s_{min} \geq$ [mm]	35	45	50
Minimaler Randabstand	$c_{min} \geq$ [mm]	35	45	50
Hilti Setzgerät ¹⁾		SIW 6(AT)-A22 SIW 4(AT)-22 SI-AT-22 Modul optional	SIW 22T-A SIW 6(AT)-A22 SIW 4(AT)-22 SIW 6(AT)-22 SI-AT-22 Modul optional	

¹⁾ Installation mit anderem Tangential-Schlagschrauber bei gleichwertiger Leistung ist zulässig.

Hilti Betonschraube HUS4

Verwendungszweck
Montagekennwerte

Anhang B8

Tabelle B13: Montagekennwerte HUS4-HR/-CR 10 und 14

Größe HUS4 Typ	10 HR, CR		14 HR	
	h_{nom1}	h_{nom2}	h_{nom1}	h_{nom2}
Länge des Dübels im Beton h_{nom} [mm]	70	90	70	110
Bohrerennendurchmesser d_o [mm]	10		14	
Bohrerschneidendurchmesser $d_{cut} \leq$ [mm]	10,45		14,50	
Durchgangsloch im Anbauteil Durchsteckmontage $d_f \leq$ [mm]	14		18	
Schlüsselweite (H-Typ) s [mm]	15		21	
Torx-Größe (C-Typ) TX [-]	50		-	
Durchmesser Senkkopf d_h [mm]	21		-	
Bohrlochtiefe für gereinigte Bohrlöcher Hammerbohren oder ungereinigt Hammerbohren Überkopf $h_1 \geq$ [mm]	$h_{nom} + 10\text{mm}$			
	80	100	80	120
Bohrlochtiefe für ungereinigte Bohrlöcher Hammerbohren in Wand und Bodenposition $h_1 =$ [mm]	$h_{nom} + 30\text{mm}$		$h_{nom} + 40\text{mm}$	
	100	120	100	120
Maximales Anziehdrehmoment T_{inst} [Nm]	45		65	
Minimale Dicke des Betonbauteils $h_{min} \geq$ [mm]	$h_1 + 30\text{mm}$			
	120	140	140	160
Minimum spacing $s_{min} \geq$ [mm]	50		50	60
Minimaler Achsabstand $c_{min} \geq$ [mm]	50		50	60
Hilti Setzgerät ¹⁾	SIW 22T-A SIW 6(AT)-A22 SIW 4(AT)- 22 SIW 6(AT)-22 SI-AT-22 Modul optional		SIW 22T-A SIW 6(AT)-22 SIW 8-22 gear 1 SIW 9-A22 SI-AT-22 Modul optional	

¹⁾ Installation mit anderem Tangential-Schlagschrauber bei gleichwertiger Leistung ist zulässig.

Hilti Betonschraube HUS4

Verwendungszweck
Montagekennwerte

Anhang B9

Setzanweisung

Bohrlocherstellung und Reinigung

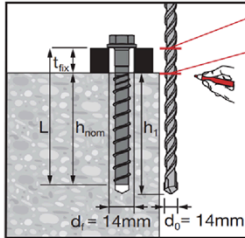

Richtige Bohrerdurchmesser auswählen.
Bohrtiefe h_1 für Vor- oder Durchsteckmontage markieren.
Details zur Bohrlochtiefe h_1 für die verschiedenen Bohrmethoden (mit und ohne Reinigung) sowie für unterschiedliche Bohrrichtungen werden in den Tabellen B9 bis B13 angegeben.

Hammerbohren (HD)

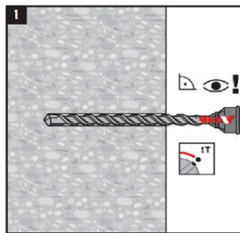

Hammerbohren (HD):

- Alle Größen in Kohlenstoff- und Edelstahl

Es ist keine Reinigung erforderlich, wenn:

- nach oben gebohrt wird
- vertikal nach unten oder horizontal gebohrt wird und nach dem Bohren dreimal gelüftet¹⁾ wird.
- Die h_1 nach Tabellen B9 bis B13 eingehalten wird.

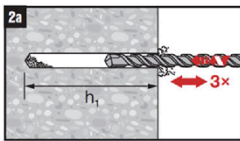

Den Bohrer dreimal aus dem Bohrloch ziehen und wieder hineinschieben, nachdem die empfohlene Bohrlochtiefe h_1 erreicht wurde. Dieses Vorgehen soll sowohl im Drehmodus wie auch im Hammermodus der Bohrmaschine durchgeführt werden. Genauere Informationen sind in der relevanten Gebrauchsanweisung (MPII) enthalten.

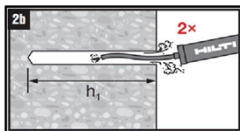

Die Reinigung ist erforderlich:

- wenn vertikal nach unten oder horizontal gebohrt wird
- Für HUS4 16 (nicht für 16 G02)

Hammerbohren mit Hilti Hohlbohrer (HDB)

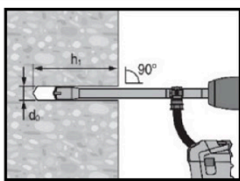

Hammerbohren mit Hilti Hohlbohrer (HDB):

- Größen 12 und 14 in Kohlenstoffstahl
- Keine Reinigung notwendig

Diamantbohren (DD)

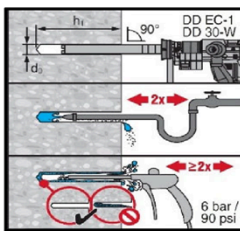

Diamond coring (DD)

- Größen 10 bis 14 in Kohlenstoffstahl
- Mit Reinigung des Bohrlochs zur Montage in alle Richtungen

Hilti Betonschraube HUS4

Verwendungszweck
Setzanweisung

Anhang B10

Setzen des Dübels

SIW 6AT-A22 1/2", SIW 4AT-22 1/2"	✗
SIW 6-22 1/2"	✓
SIW 22T-A 1/2", SIW 22T-A 3/4"	✓
SIW 9-A22 3/4"	✓
SIW 8-22 1/2"	✓
SIW 10-22 3/4"	✓

Den passenden Schlagschrauber für die verwendete Schraube auswählen (siehe Tabellen B9 bis B13).

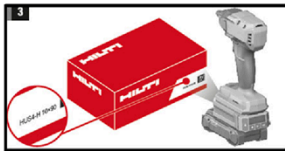

Optional: Das SI-AT-22 Modul zwischen Akku und Gerät einsetzen und die verwendete Schraube im Menü auswählen oder die Dübelverpackung einscannen (in diesem Fall wird der Gang automatisch ausgewählt, siehe Tabellen B5 bis B7).

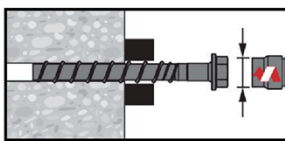

Montage mit einem Schlagschrauber.
Bei Verwendung des SI-AT-22-Moduls ist das Einstellen des Gangs am Gerät nicht erforderlich.

Optional: Adjustierungsverfahren (nur für Kohlenstoffschrauben)

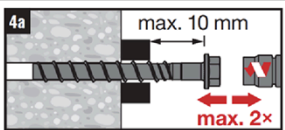

Der Dübel darf maximal zweimal adjustiert werden. Die bei der Adjustierung erfolgte Unterfüterung darf insgesamt maximal 10 mm betragen.

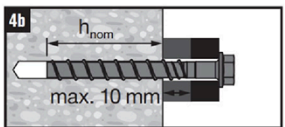

Die Verankerungstiefe nach dem Adjustierungsverfahren muss größer oder gleich der geforderten Verankerungstiefe sein (z. B. h_{nom1} , h_{nom2} oder h_{nom3}).

Kontrolle der Setzung

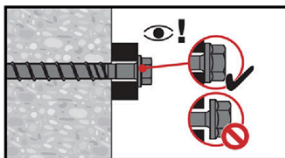

Der Schraubenkopf muss in Kontakt mit dem Anbauteil sein

Optional: Setzen des Dübels mit Hilti Verfüll-Set

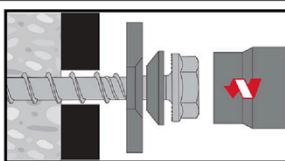

Setzen mit Hilti Verfüll-Set

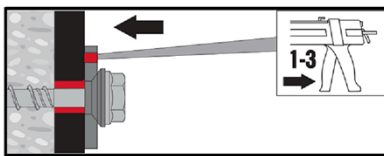

Ringspalt zwischen Stahlelement und Anbauteil mit einem Hilti Injektionsmörtel HIT-HY --- oder HIT-RE ... mit 1 bis 3 Hüben verfüllen. Befolgen Sie die Bedienungsanleitung, die dem entsprechenden Hilti Injektionsmörtel beigelegt ist. Nach Ablauf der erforderlichen Aushärtezeit t_{cure} kann die Befestigung belastet werden.

Hilti Betonschraube HUS4

Verwendungszweck
Setzanweisung

Anhang B11

Tabelle C1: Wesentliche Merkmale unter statische und quasi-statische Lasten in Beton für HUS4 Kohlenstoffstahl Größe 8 und 10

Größe HUS4			8			8			10		
Typ			H(F), C			T-H(F), T-C			H(F), C, A(F)		
Länge des Dübels im Beton	h_{nom}	[mm]	h_{nom1}	h_{nom2}	h_{nom3}	h_{nom1}	h_{nom2}	h_{nom3}	h_{nom1}	h_{nom2}	h_{nom3}
			40	60	70	50	60	70	55	75	85
Adjustierung											
Max. Dicke der Unterfütterung	t_{adj}	[mm]	-	10	10	-	10	10	-	10	10
Max. Anzahl der Adjustierungen	n_a	[-]	-	2	2	-	2	2	-	2	2
Stahlversagen unter Zugbeanspruchung											
Charakteristischer Widerstand	$N_{Rk,s}$	[kN]	36,0			39,2			55,0		
Teilsicherheitsbeiwert	$\gamma_{Ms,N}^{1)}$	[-]	1,5			1,4			1,5		
Herausziehen											
Charakteristischer Widerstand in ungerissenem Beton C20/25	$N_{Rk,p,ucr}$	[kN]	$\geq N_{Rk,c}^{0,3)}$			9	12	16	13	22	$\geq N_{Rk,c}^{0,3)}$
Charakteristischer Widerstand in gerissenem Beton C20/25	$N_{Rk,p,cr}$	[kN]	5,5	$\geq N_{Rk,c}^{0,3)}$		6	9	12	$\geq N_{Rk,c}^{0,3)}$		
Erhöhungsfaktor für $N_{Rk,p} = N_{Rk,p(C20/25)} * \psi_c$	ψ_c	[-]	$(f_{ck}/20)^{0,5}$								
Betonausbruch und Spalten											
Effektive Verankerungstiefe	$h_{ef}^{2)}$	[mm]	30,6	47,6	56,1	40	46,4	54,9	42,5	59,5	68,0
Faktor für	ungerissenen Beton	$k_{ucr,N}$	11,0								
	gerissenen Beton	$k_{cr,N}$	7,7								
Betonausbruch	Randabstand	$c_{cr,N}$	$1,5 h_{ef}$								
	Achsabstand	$s_{cr,N}$	$3 h_{ef}$								
Charakteristischer Widerstand	$N_{Rk,sp}^0$	[kN]	$\min(N_{Rk,p}; N_{Rk,c}^{0,2),3)})$								
Spalten	Randabstand	$c_{cr,sp}$	$1,5 h_{ef}$			$1,5 h_{ef}$			$1,65 h_{ef}$		
	Achsabstand	$s_{cr,sp}$	$3,0 h_{ef}$			$3,0 h_{ef}$			$3,30 h_{ef}$		
Montagebeiwert	γ_{inst}	[-]	1,0						1,2	1,0	

1) Sofern andere nationale Regelungen fehlen.

2) Wenn $h_{nom} > h_{nom1}$ und $< h_{nom3}$, kann das aktuelle h_{ef} für Betonausbruch nach den Tabellen A4, A5 oder A7 gerechnet werden

3) $N_{Rk,c}^0$ für C20/25 gemäß EN 1992-4:2018

Hilti Betonschraube HUS4

Leistungen

Wesentliche Merkmale unter statische und quasi-statische Lasten in Beton

Anhang C1

Tabelle C1 fortgesetzt

Größe HUS4 Typ		8 H(F), C			8 T-H(F), T-C			10 H(F), C, A(F)		
		h_{nom1}	h_{nom2}	h_{nom3}	h_{nom1}	h_{nom2}	h_{nom3}	h_{nom1}	h_{nom2}	h_{nom3}
Länge des Dübels im Beton	h_{nom} [mm]	40	60	70	50	60	70	55	75	85
Stahlversagen unter Querbeanspruchung										
Charakteristischer Widerstand	$V_{RK,s}^0$ [kN]	18,8	21,9		19,0	22,0		28,8	32,0	
Teilsicherheitsbeiwert	$\gamma_{Ms,V}^{1)}$ [-]	1,25			1,50			1,25		
Duktilitätsfaktor	k_7 [-]	0,8								
Charakteristischer Widerstand	$M_{RK,s}^0$ [Nm]	32			46			64		
Betonausbruch auf der lastabgewandten Seite (pry-out)										
Pry-out Faktor	k_8 [-]	1,0	2,0		1,0	2,0		1,0	2,0	
Betonkantenbruch										
Wirksame Dübellänge	l_f [mm]	40	60	70	50	60	70	55	75	85
Wirksamer Außendurchmesser	d_{nom} [mm]	8			8			10		

¹⁾ Sofern andere nationale Regelungen fehlen.

Hilti Betonschraube HUS4

Leistungen

Wesentliche Merkmale unter statische und quasi-statische Lasten in Beton

Anhang C2

Tabelle C2: Wesentliche Merkmale unter statische und quasi-statische Lasten in Beton für HUS4 Kohlenstoffstahl Größe 10 bis 14

Größe HUS4			10			12			14		
Typ			T-H(F), T-C			H(F)			H(F), A(F)		
Länge des Dübels im Beton	h_{nom}	[mm]	h_{nom1}	h_{nom2}	h_{nom3}	h_{nom1}	h_{nom2}	h_{nom3}	h_{nom1}	h_{nom2}	h_{nom3}
			55	75	85	60	80	100	65	85	115
Adjustierung											
Max. Dicke der Unterfütterung	t_{adj}	[mm]	-	10	10	10	10	10	10	10	10
Max. Anzahl der Adjustierungen	n_a	[-]	-	2	2	2	2	2	2	2	2
Stahlversagen unter Zugbeanspruchung											
Charakteristischer Widerstand	$N_{Rk,s}$	[kN]	62,2			79,0			101,5		
Teilsicherheitsbeiwert	$\gamma_{Ms,N}^{1)}$	[-]	1,4			1,5					
Herausziehen											
Charakteristischer Widerstand in ungerissenem Beton C20/25	$N_{Rk,p,ucr}$	[kN]	12	20	32	$\geq N_{Rk,c}^{0,3)}$					
Charakteristischer Widerstand in gerissenem Beton C20/25	$N_{Rk,p,cr}$	[kN]	9	15	19	10	$\geq N_{Rk,c}^{0,3)}$				
Erhöhungsfaktor für $N_{Rk,p} = N_{Rk,p(C20/25)} * \psi_c$	ψ_c	[-]	$(f_{ck}/20)^{0,5}$								
Betonausbruch und Spalten											
Effektive Verankerungstiefe	$h_{ef}^{2)}$	[mm]	41,6	58,6	67,1	45,9	62,9	79,9	49,3	66,3	91,8
Faktor für	ungerissenen Beton	$k_{ucr,N}$				11,0					
	gerissenen Beton	$k_{cr,N}$				7,7					
Betonausbruch	Randabstand	$c_{cr,N}$				1,5 h_{ef}					
	Achsabstand	$s_{cr,N}$				3 h_{ef}					
Charakteristischer Widerstand	$N_{Rk,sp}^{0,3)}$	[kN]	$\min(N_{Rk,p}; N_{Rk,c}^{2),3)}$								
Spalten	Randabstand	$c_{cr,sp}$	1,60 h_{ef}			1,65 h_{ef}			1,60 h_{ef}		
	Achsabstand	$s_{cr,sp}$	3,20 h_{ef}			3,30 h_{ef}			3,20 h_{ef}		
Montagebeiwert	γ_{inst}	[-]				1,0					

¹⁾ Sofern andere nationale Regelungen fehlen.

²⁾ Wenn $h_{nom} > h_{nom1}$ und $< h_{nom3}$ kann das aktuelle h_{ef} für Betonausbruch nach den Tabellen A4, A5 oder A7 gerechnet werden

³⁾ $N_{Rk,c}$ für C20/25 gemäß EN 1992-4:2018

Hilti Betonschraube HUS4

Leistungen

Wesentliche Merkmale unter statische und quasi-statische Lasten in Beton

Anhang C3

Tabelle C2 fortgesetzt

Größe HUS4			10			12			14		
Typ			T-H(F), T-C			H(F)			H(F), A(F)		
Länge des Dübels im Beton	h_{nom}	[mm]	h_{nom1}	h_{nom2}	h_{nom3}	h_{nom1}	h_{nom2}	h_{nom3}	h_{nom1}	h_{nom2}	h_{nom3}
			55	75	85	60	80	100	65	85	115
Stahlversagen unter Querbeanspruchung											
Charakteristischer Widerstand	$V_{RK,s}^0$	[kN]	30		34	38,9		44,9	55		62
Teilsicherheitsbeiwert	$\gamma_{Ms,V}^{1)}$	[-]	1,50			1,25					
Duktilitätsfaktor	k_7	[-]	0,8								
Charakteristischer Widerstand	$M_{RK,s}^0$	[Nm]	92			120			186		
Betonausbruch auf der lastabgewandten Seite (pry-out)											
Pry-out Faktor	k_8	[-]	1,0	2,0		2,0					
Betonkantenbruch											
Wirksame Dübellänge	l_f	[mm]	55	75	85	60	80	100	65	85	115
Wirksamer Außendurchmesser	d_{nom}	[mm]	10			12			14		

¹⁾ Sofern andere nationale Regelungen fehlen.

Hilti Betonschraube HUS4

Leistungen

Wesentliche Merkmale unter statische und quasi-statische Lasten in Beton

Anhang C4

Tabelle C3: Wesentliche Merkmale unter statische und quasi-statische Lasten in Beton für HUS4 Kohlenstoffstahl Größe 16

Größe HUS4			16		16			16
Typ			H(F)		H(F) G02			DW
Länge des Dübels im Beton	h_{nom}	[mm]	h_{nom1}	h_{nom2}	h_{nom1}	h_{nom2}	h_{nom3}	h_{nom}
			85	130	85	110	130	130
Adjustierung								
Max. Dicke der Unterfütterung	t_{adj}	[mm]	-	-	10	10	10	-
Max. Anzahl der Adjustierungen	n_{adj}	[-]	-	-	2	2	2	-
Steel failure for tension load								
Charakteristischer Widerstand	$N_{RK,s}$	[kN]	107,7		141,9			120,0
Teilsicherheitsbeiwert	$\gamma_{Ms,N}^{1)}$	[-]	1,5		1,5			1,5
Herausziehen								
Charakteristischer Widerstand in ungerissenem Beton C20/25	$N_{RK,p,ucr}$	[kN]	22	46	$\geq N_{RK,c}^{0(2),3)}$			$\geq N_{RK,c}^{0(2),3)}$
Charakteristischer Widerstand in gerissenem Beton C20/25	$N_{RK,p,cr}$	[kN]	16	32	$\geq N_{RK,c}^{0(2),3)}$			$\geq N_{RK,c}^{0(2),3)}$
Erhöhungsfaktor für $N_{RK,p} = N_{RK,p(C20/25)} * \psi_c$	ψ_c	[-]	$(f_{ck}/20)^{0,5}$					
Betonausbruch und Spalten								
Effektive Verankerungstiefe	$h_{ef}^{2)}$	[mm]	66,6	104,9	66,1	87,3	104,3	104,3
Faktor für	ungerissenen Beton	$k_{ucr,N}$	11,0		11,0			11,0
	gerissenen Beton	$k_{cr,N}$	7,7		7,7			7,7
Betonausbruch	Randabstand	$c_{cr,N}$	1,5 h_{ef}					
	Achsabstand	$s_{cr,N}$	3 h_{ef}					
Charakteristischer Widerstand	$N_{RK,sp}^0$	[kN]	$\min(N_{RK,p}; N_{RK,c}^{0(2),3})$					
Erforderliche Spaltfläche	$A_{sp,rqd}$	[-]	-		$(N_{RK,sp}^0 + 2,81) / 0,000745$			
Spalten	Randabstand	$c_{cr,sp}$	1,60 h_{ef}		$\min \left[\frac{A_{sp,rqd} + 0,8 \cdot (h_{min} - h_{ef})^2}{3,41 \cdot h_{min} - 0,59 \cdot h_{ef}}; \frac{A_{sp,rqd}}{s_{min} \cdot \sqrt{8}} \right]$ $\geq (1,50 \cdot h_{ef})$			
	Achsabstand	$s_{cr,sp}$	3,20 h_{ef}		2,00 $c_{cr,sp}$			
Montagebeiwert	γ_{inst}	[-]	1,0		1,0			

1) Sofern andere nationale Regelungen fehlen.

2) Wenn $h_{nom} > h_{nom1}$ und $< h_{nom3}$ kann das gerechnete h_{ef} für Betonausbruch und Herausziehen nach den Tabellen A5 oder A8 gerechnet werden

3) $N_{RK,c}^0$ für C20/25 nach EN 1992-4:2018

Hilti Betonschraube HUS4

Leistungen

Wesentliche Merkmale unter statische und quasi-statische Lasten in Beton

Anhang C5

Tabelle C3 fortgesetzt

Größe HUS4		16		16			16
Typ		H(F)		H(F) G02			DW
Länge des Dübels im Beton	h_{nom} [mm]	h_{nom1}	h_{nom2}	h_{nom1}	h_{nom2}	h_{nom3}	h_{nom}
		85	130	85	110	130	130
Stahlversagen unter Querbeanspruchung							
Charakteristischer Widerstand	$V^0_{Rk,s}$ [kN]	65,1	73,1	77,8		82,9	68,0
Teilsicherheitsbeiwert	$\gamma_{Ms,V}^{1)}$ [-]	1,25					
Duktilitätsfaktor	k_7 [-]	0,8					
Charakteristischer Widerstand	$M^0_{Rk,s}$ [Nm]	240		350		283	
Betonausbruch auf der lastabgewandten Seite (pry-out)							
Pry-out Faktor	k_8 [-]	2,0					
Betonkantenbruch							
Wirksame Dübellänge	l_f [mm]	85	130	85	110	130	130
Wirksamer Außendurchmesser	d_{nom} [mm]	16		16		16	

¹⁾ Sofern andere nationale Regelungen fehlen.

Hilti Betonschraube HUS4

Leistungen

Wesentliche Merkmale unter statische und quasi-statische Lasten in Beton

Anhang C6

Tabelle C4: Wesentliche Merkmale unter statische und quasi-statische Lasten in Beton für HUS4 nichtrostender Stahl

Größe HUS4			6		8		10		14	
Typ			HR, CR		HR, CR		HR, CR		HR	
Länge des Dübels im Beton	h_{nom}	[mm]	h_{nom1}	h_{nom1}	h_{nom2}	h_{nom1}	h_{nom2}	h_{nom1}	h_{nom2}	
			55	60	80	70	90	70	110	
Stahlversagen unter Zugbeanspruchung Querbeanspruchung										
Charakteristischer Widerstand	$N_{Rk,s}$	[kN]	24,0	34,0	52,6	102,2				
Teilsicherheitsbeiwert	$\gamma_{Ms,N}^{1)}$	[-]	1,4							
Charakteristischer Widerstand	$V_{Rk,s}$	[kN]	17,0	26,0	33,0	55,0	77,0			
Teilsicherheitsbeiwert	$\gamma_{Ms,V}^{1)}$	[-]	1,5							
Duktilitätsfaktor	k_7	[-]	1,0							
Charakteristischer Widerstand	$M^0_{Rk,s}$	[Nm]	19	36	66	193				
Herausziehen										
Charakteristischer Widerstand in gerissenem Beton C20/25	$N_{Rk,p,cr}$	[kN]	5	8,5	15	12	16	12	25	
Charakteristischer Widerstand in ungerissenem Beton C20/25	$N_{Rk,p,ucr}$	[kN]	9	12	16	16	25	$\geq N^0_{Rk,c}^{3)}$		
Erhöhungsfaktor für $N_{Rk,p} = N_{Rk,p(C20/25)} * \psi_c$	ψ_c	[-]	$(f_{ck}/20)^{0,5}$							
Betonausbruch und Spalten										
Effektive Verankerungstiefe	$h_{ef}^{2)}$	[mm]	45	47	64	54	71	52	86	
Faktor für	ungerissenen Beton	$k_1 = k_{cr,N}$	7,7							
	gerissenen Beton	$k_1 = k_{ucr,N}$	11,0							
Betonausbruch	Randabstand	$c_{cr,N}$	1,5 h_{ef}							
	Achsabstand	$s_{cr,N}$	3 h_{ef}							
Charakteristischer Widerstand	$N^0_{Rk,sp}$	[kN]	$N_{Rk,p}$							
Spalten	Randabstand	$c_{cr,sp}$	1,5 h_{ef}	1,5 h_{ef}	1,8 h_{ef}	1,8 h_{ef}				
	Achsabstand	$s_{cr,sp}$	3 h_{ef}	3 h_{ef}	3,6 h_{ef}	3,6 h_{ef}				
Montagebeiwert	γ_{inst}	[-]	1,4	1,0	1,2	1,2	1,0	1,2		
Betonausbruch auf der lastabgewandten Seite (pry-out)										
Pry-out Faktor	k_8	[mm]	1,5	2,0						
Betonkantenbruch										
Wirksame Dübellänge	$l_f = h_{ef}$	[mm]	55	60	80	70	90	70	110	
Wirksamer Außendurchmesser	d_{nom}	[mm]	6	8	10	14				

1) Sofern andere nationale Regelungen fehlen.

2) Wenn $h_{nom} > h_{nom1}$ und $< h_{nom2}$ kann das aktuelle h_{ef} für Betonausbruch nach den Tabellen A6 oder A7 gerechnet werden

3) $N^0_{Rk,c}$ für C20/25 gemäß EN 1992-4:2018

Hilti Betonschraube HUS4

Leistungen

Wesentliche Merkmale unter statische und quasi-statische Lasten in Beton

Anhang C7

Tabelle C5: Wesentliche Merkmale für die seismische Einwirkung C1 in Beton für HUS4 Kohlenstoffstahl Größe 8 und 10

Größe HUS4			8		8			10		
Typ			H(F), C		T-H(F), T-C			H(F), C, A(F)		
			h_{nom2}	h_{nom3}	h_{nom1}	h_{nom2}	h_{nom3}	h_{nom1}	h_{nom2}	h_{nom3}
Länge des Dübels im Beton	h_{nom}	[mm]	60	70	50	60	70	55	75	85
Adjustierung										
Max. Dicke der Unterfütterung	t_{adj}	[mm]	10	10	-	10	10	-	10	10
Max. Anzahl der Adjustierungen	n_a	[-]	2	2	-	2	2	-	2	2
Stahlversagen unter Zug- und Querbeanspruchung										
Charakteristischer Widerstand	$N_{RK,s,C1}$	[kN]	36,0		39,2			55,0		
Teilsicherheitsbeiwert	$\gamma_{Ms,N}^{1)}$	[-]	1,5		1,4			1,5		
Charakteristischer Widerstand	$V_{RK,s,C1}$	[kN]	18,8		16,5			26,1	26,7	
Teilsicherheitsbeiwert	$\gamma_{Ms,V}^{1)}$	[-]	1,25		1,5			1,25		
Abminderungsfaktor nach EN 1992-4: 2018 für nicht verfüllten Ringspalt	α_{gap}	[-]			0,5					
Abminderungsfaktor nach EN 1992-4: 2018 für verfüllten Ringspalt	α_{gap}	[-]			1,0					
Herausziehen										
Charakteristischer Widerstand in gerissenem Beton	$N_{RK,p,C1}$	[kN]	$\geq N_{RK,c}^{0) 3)}$		6	9	12	$\geq N_{RK,c}^{0) 3)}$		
Betonausbruch										
Effektive Verankerungstiefe	$h_{ef}^{2)}$	[mm]	47,6	56,1	40	46,4	54,9	42,5	59,5	68,0
Betonausbruch	Randabstand	$c_{cr,N}$			1,5 h_{ef}					
	Achsabstand	$s_{cr,N}$			3 h_{ef}					
Montagebeiwert	γ_{inst}	[-]			1,0			1,2	1,0	
Betonausbruch auf der lastabgewandten Seite (pry-out)										
Pry-out Faktor	k_8	[-]	2,0		1,0	2,0		1,0	2,0	
Betonkantenbruch										
Wirksame Dübellänge	l_f	[mm]	60	70	50	60	70	55	75	85
Wirksamer Außendurchmesser	d_{nom}	[mm]	8		8			10		

1) Sofern andere nationale Regelungen fehlen.

2) Wenn $h_{nom} > h_{nom1}$ und $< h_{nom3}$ kann das aktuelle h_{ef} für Betonausbruch nach den Tabellen A4, A5 oder A7 gerechnet werden

3) $N_{RK,c}^{0)}$ für C20/25 gemäß EN 1992-4:2018

Hilti Betonschraube HUS4

Leistungen

Wesentliche Merkmale unter statische und quasi-statische Lasten in Beton

Anhang C8

Tabelle C6: Wesentliche Merkmale für die seismische Einwirkung C1 in Beton für HUS4 Kohlenstoffstahl Größe 10 bis 14

Größe HUS4			10			12			14		
Typ			T-H(F), T-C			H(F)			H(F), A(F)		
			h_{nom1}	h_{nom2}	h_{nom3}	h_{nom1}	h_{nom2}	h_{nom3}	h_{nom1}	h_{nom2}	h_{nom3}
Länge des Dübels im Beton	h_{nom}	[mm]	55	75	85	60	80	100	65	85	115
Adjustierung											
Max. Dicke der Unterfütterung	t_{adj}	[mm]	-	10	10	10	10	10	10	10	10
Max. Anzahl der Adjustierungen	n_a	[-]	-	2	2	2	2	2	2	2	2
Stahlversagen unter Zug- und Querbeanspruchung											
Charakteristischer Widerstand	$N_{Rk,s,C1}$	[kN]	62,2			79,0			101,5		
Teilsicherheitsbeiwert	$\gamma_{Ms,N}^{1)}$	[-]				1,5					
Charakteristischer Widerstand	$V_{Rk,s,C1}$	[kN]	25,7			33,2	38,9		46,0		
Teilsicherheitsbeiwert	$\gamma_{Ms,V}^{1)}$	[-]	1,5			1,25					
Abminderungsfaktor nach EN 1992-4: 2018 für nicht verfüllten Ringspalt	α_{gap}	[-]				0,5					
Abminderungsfaktor nach EN 1992-4: 2018 für verfüllten Ringspalt	α_{gap}	[-]				1,0					
Herausziehen											
Charakteristischer Widerstand in gerissenem Beton	$N_{Rk,p,C1}$	[kN]	9	15	19	$\geq N_{Rk,c}^{3)}$					
Betonausbruch											
Effektive Verankerungstiefe	$h_{ef}^{2)}$	[mm]	41,6	58,6	67,1	45,9	62,9	79,9	49,3	66,3	91,8
Betonausbruch	Randabstand	$c_{cr,N}$				1,5 h_{ef}					
	Achsabstand	$s_{cr,N}$				3 h_{ef}					
Montagebeiwert		[-]				1,0					
Betonausbruch auf der lastabgewandten Seite (pry-out)											
Pry-out Faktor	k_8	[-]	1,0	2,0		2,0					
Betonkantenbruch											
Wirksame Dübellänge	l_f	[mm]	55	75	85	60	80	100	65	85	115
Wirksamer Außendurchmesser	d_{nom}	[mm]	10			12			14		

1) Sofern andere nationale Regelungen fehlen.

2) Wenn $h_{nom} > h_{nom1}$ und $< h_{nom3}$ kann das aktuelle h_{ef} für Betonausbruch nach den Tabellen A4, A5 oder A7 gerechnet werden

3) $N_{Rk,c}$ für C20/25 gemäß EN 1992-4:2018

Hilti Betonschraube HUS4

Leistungen

Wesentliche Merkmale für die seismische Einwirkung C1 in Beton

Anhang C9

Tabelle C7: Wesentliche Merkmale für die seismische Einwirkung C1 in Beton für HUS4 Kohlenstoffstahl Größe 16

Fastener size HUS4		16		16			16
Typ		H(F)		H(F) G02			DW
		h_{nom1}	h_{nom2}	h_{nom1}	h_{nom2}	h_{nom3}	h_{nom}
Nominal embedment depth	h_{nom} [mm]	85	130	85	110	130	130
Adjustierung							
Max. Dicke der Unterfütterung	t_{adj} [mm]	-	-	10	10	10	10
Max. Anzahl der Adjustierungen	n_{ad} [-]	-	-	2	2	2	2
Stahlversagen unter Zug- und Querbeanspruchung							
Charakteristischer Widerstand	$N_{Rk,s,C1}$ [kN]	107,7		141,9			120
Teilsicherheitsbeiwert	$\gamma_{Ms,N}^{1)}$ [-]	1,5		1,5			1,5
Charakteristischer Widerstand	$V_{Rk,s,C1}$ [kN]	42,9	25,3	47,9	47,9	51,0	37,0
Teilsicherheitsbeiwert	$\gamma_{Ms,V}^{1)}$ [-]	1,25					
Abminderungsfaktor nach EN 1992-4: 2018 für nicht verfüllten Ringspalt	α_{gap} [-]	0,5					
Abminderungsfaktor nach EN 1992-4: 2018 für verfüllten Ringspalt	α_{gap} [-]	1,0					
Herausziehen							
Charakteristischer Widerstand in gerissenem Beton	$N_{Rk,p,C1}$ [kN]	7,5	19,0	$\geq N_{Rk,c}^{0,2),3)}$			$\geq N_{Rk,c}^{0,2),3)}$
Betonausbruch							
Effektive Verankerungstiefe	$h_{ef}^{2)}$ [mm]	66,6	104,9	66,1	87,3	104,3	104,3
Betonausbruch	Randabstand $c_{cr,N}$ [mm]	1,5 h_{ef}		1,5 h_{ef}			
	Achsabstand $s_{cr,N}$ [mm]	3 h_{ef}		3 h_{ef}			
Montagebeiwert	γ_{inst} [-]	1,0		1,0			
Betonausbruch auf der lastabgewandten Seite (pry-out)							
Pry-out Faktor r	k_8 [-]	2,0					
Betonkantenbruch							
Wirksame Dübellänge	l_f [mm]	85	130	85	110	130	130
Wirksamer Außendurchmesser	d_{nom} [mm]	16					

1) Sofern andere nationale Regelungen fehlen.

2) Wenn $h_{nom} > h_{nom1}$ und $< h_{nom2}$ kann das aktuelle h_{ef} für Betonausbruch und Herausziehen nach den Tabellen A5 gerechnet werden

3) $N_{Rk,c}^0$ für C20/25 nach EN 1992-4:2018

Hilti Betonschraube HUS4

Leistungen

Wesentliche Merkmale für die seismische Einwirkung C1 in Beton

Anhang C10

Tabelle C8: Wesentliche Merkmale für die seismische Einwirkung C1 in Beton für HUS4 nichtrostender Stahl

Größe HUS4		8	10	14
Typ		HR, CR	HR, CR	HR
Länge des Dübels im Beton	h_{nom} [mm]	80	90	110
Stahlversagen unter Zug- und Querbeanspruchung				
Charakteristischer Widerstand	$N_{RK,s,C1}$ [kN]	34,0	52,6	102,2
Teilsicherheitsbeiwert	$\gamma_{Ms,N}^{1)}$ [-]	1,4		
Charakteristischer Widerstand	$V_{RK,s,C1}$ [kN]	11,1	17,9	53,9
Teilsicherheitsbeiwert	$\gamma_{Ms,V}^{1)}$ [-]	1,5		
Herausziehen				
Charakteristischer Widerstand in gerissenem Beton	$N_{RK,p,C1}$ [kN]	7,7	12,5	17,5
Betonausbruch				
Effektive Verankerungstiefe	$h_{ef}^{2)}$ [mm]	64	71	86
Betonausbruch	Randabstand	$c_{cr,N}$ [mm]	1,5 h_{ef}	
	Achsabstand	$s_{cr,N}$ [mm]	3 h_{ef}	
Montagebeiwert	γ_{inst} [-]	1,2	1,0	1,2
Betonausbruch auf der lastabgewandten Seite (pry-out)				
Pry-out Faktor	k_8 [-]	2,0		
Betonkantenbruch				
Wirksame Dübellänge	$l_f = h_{ef}$ [mm]	64	71	86
Wirksamer Außendurchmesser	d_{nom} [mm]	8	10	14

¹⁾ Sofern andere nationale Regelungen fehlen.

Hilti Betonschraube HUS4

Leistungen
Wesentliche Merkmale für die seismische Einwirkung C1 in Beton

Anhang C11

Tabelle C9: Wesentliche Merkmale für die seismische Einwirkung C2 in Beton für HUS4 Kohlenstoffstahl Größe 8 und 10

Größe HUS4			8		8			10				
Typ			H(F), C		T-H(F), T-C			H(F), C, A(F)				
Länge des Dübels im Beton			h_{nom2}	h_{nom3}	h_{nom1}	h_{nom2}	h_{nom3}	h_{nom1}	h_{nom2}	h_{nom3}		
			60	70	50	60	70	55	75	85		
Adjustierung												
Max. Dicke der Unterfütterung			t_{adj}	[mm]	10	10	-	10	10	-	10	10
Max. Anzahl der Adjustierungen			n_a	[-]	2	2	-	2	2	-	2	2
Stahlversagen unter Zugbeanspruchung												
Charakteristischer Widerstand			$N_{Rk,s,C2}$	[kN]	36,0		39,2			55,0		
Teilsicherheitsbeiwert			$\gamma_{Ms,N}^{1)}$	[-]	1,5		1,4			1,5		
Stahlversagen unter Querbeanspruchung												
Teilsicherheitsbeiwert			$\gamma_{Ms,V}^{1)}$	[-]	1,25		1,5			1,25		
Montage mit Hilti Verfüll-Set (HUS4-H und HUS4-A)												
Charakteristischer Widerstand			$V_{Rk,s,C2}$	[kN]	8,7	16,0	9,2	14,7	15,1	23,2		
Abminderungsfaktor nach EN 1992-4:2018 für verfüllten Ringspalt			α_{gap}	[-]	1,0							
Montage ohne Hilti Verfüll-Set												
Charakteristischer Widerstand			$V_{Rk,s,C2}$	[kN]	8,7	10,8	9,2	10,8	14,8			
Abminderungsfaktor nach EN 1992-4:2018 für verfüllten Ringspalt			α_{gap}	[-]	0,5							
Herausziehen												
Charakteristischer Widerstand in gerissenem Beton			$N_{Rk,p,C2}$	[kN]	1,8	2,7	2,3	2,8	3,2	2,6	3,6	5,4
Betonausbruch												
Effektive Verankerungstiefe			$h_{ef}^{2)}$	[mm]	47,6	56,1	40	46,4	54,9	42,5	59,5	68,0
Beton-ausbruch			Randabstand	$c_{cr,N}$	[mm]	1,5 h_{ef}						
			Achsabstand	$s_{cr,N}$	[mm]	3 h_{ef}						
Montagebeiwert			γ_{inst}	[-]	1,0			1,2	1,0			
Betonausbruch auf der lastabgewandten Seite (pry-out)												
Pry-out Faktor			k_8	[-]	2,0	1,0	2,0	1,0	2,0			
Betonkantenbruch												
Wirksame Dübellänge			l_f	[mm]	60	70	50	60	70	55	75	85
Wirksamer Außendurchmesser			d_{nom}	[mm]	8		8			10		

¹⁾ Sofern andere nationale Regelungen fehlen.

²⁾ Wenn $h_{nom} > h_{nom1}$ und $< h_{nom3}$ kann das aktuelle h_{ef} für Betonausbruch nach den Tabellen A4, A5 oder A7 gerechnet werden

Hilti Betonschraube HUS4

Leistungen
Wesentliche Merkmale für die seismische Einwirkung C2 in Beton

Anhang C12

Tabelle C10: Wesentliche Merkmale für die seismische Einwirkung C2 in Beton für HUS4 Kohlenstoffstahl Größe 10 bis 14

Größe HUS4			10			12			14		
Typ			T-H(F), T-C			H(F)			H(F), A(F)		
Länge des Dübels im Beton	h_{nom}	[mm]	h_{nom1}	h_{nom2}	h_{nom3}	h_{nom1}	h_{nom2}	h_{nom3}	h_{nom1}	h_{nom2}	h_{nom3}
			55	75	85	60	80	100	65	85	115
Adjustierung											
Max. Dicke der Unterfütterung	t_{adj}	[mm]	-	10	10	10	10	10	10	10	10
Max. Anzahl der Adjustierungen	n_a	[-]	-	2	2	2	2	2	2	2	2
Stahlversagen unter Zugbeanspruchung											
Charakteristischer Widerstand	$N_{RK,s,C2}$	[kN]	62,2			79,0			101,5		
Teilsicherheitsbeiwert	$\gamma_{Ms,N}^{1)}$	[-]	1,4			1,5					
Stahlversagen unter Querbeanspruchung											
Teilsicherheitsbeiwert	$\gamma_{Ms,V}^{1)}$	[-]	1,5			1,25					
Montage mit Hilti Verfüll-Set (HUS4-H und HUS4-A)											
Charakteristischer Widerstand	$V_{RK,s,C2}$	[kN]	13,3	25,6		20,0	28,6		29,2	46,5	
Abminderungsfaktor nach EN 1992-4:2018 für verfüllten Ringspalt	α_{gap}	[-]				1,0					
Montage ohne Hilti Verfüll-Set											
Charakteristischer Widerstand	$V_{RK,s,C2}$	[kN]	13,3	17,7		20,0	23,7		29,2	34,4	
Abminderungsfaktor nach EN 1992-4:2018 für verfüllten Ringspalt	α_{gap}	[-]				0,5					
Herausziehen											
Charakteristischer Widerstand in gerissenem Beton	$N_{RK,p,C2}$	[kN]	2,8	5,4	6,4	5,7	8,5	11,4	5,4	8,9	17,7
Betonausbruch											
Effektive Verankerungstiefe	$h_{ef}^{2)}$	[mm]	41,6	58,6	67,1	45,9	62,9	79,9	49,3	66,3	91,8
Beton-ausbruch	Randabstand	$c_{cr,N}$				1,5 h_{ef}					
	Achsabstand	$s_{cr,N}$				3 h_{ef}					
Montagebeiwert	γ_{inst}	[-]				1,0					
Betonausbruch auf der lastabgewandten Seite (pry-out)											
Pry-out Faktor	k_8	[-]	1,0	2,0				2,0			
Betonkantenbruch											
Wirksame Dübellänge	l_f	[mm]	55	75	85	60	80	100	65	85	115
Wirksamer Außendurchmesser	d_{nom}	[mm]	10			12			14		

¹⁾ Sofern andere nationale Regelungen fehlen.

²⁾ Wenn $h_{nom} > h_{nom1}$ und $< h_{nom3}$ kann das aktuelle h_{ef} für Betonausbruch nach den Tabellen A4, A5 oder A7 gerechnet werden

Hilti Betonschraube HUS4

Leistungen
Wesentliche Merkmale für die seismische Einwirkung C2 in Beton

Anhang C13

Tabelle C11: Wesentliche Merkmale für die seismische Einwirkung C2 in Beton für HUS4 Kohlenstoffstahl Größe 16

Fastener size HUS4		16			16
Typ		H(F) G02			DW
		h_{nom1}	h_{nom2}	h_{nom3}	h_{nom3}
Länge des Dübels im Beton	h_{nom} [mm]	85	110	130	130
Adjustierung					
Max. Dicke der Unterfütterung	t_{adj} [mm]	10	10	10	10
Max. Anzahl der Adjustierungen	n_a [-]	2	2	2	2
Stahlversagen unter Zugbeanspruchung					
Charakteristischer Widerstand	$N_{Rk,s,C2}$ [kN]	141,9			120
Teilsicherheitsbeiwert	$\gamma_{Ms,N}^{1)}$ [-]	1,5			
Stahlversagen unter Querbeanspruchung					
Teilsicherheitsbeiwert	$\gamma_{Ms,V}^{1)}$ [-]	1,25			
Montage mit Hilti Verfüll-Set					
Charakteristischer Widerstand	$V_{Rk,s,C2}$ [kN]	58,1	58,1	61,8	44,0
Abminderungsfaktor nach EN 1992-4:2018 für verfüllten Ringspalt	α_{gap} [-]	1,0			
Montage ohne Hilti Verfüll-Set					
Charakteristischer Widerstand	$V_{Rk,s,C2}$ [kN]	58,1	58,1	61,8	44,0
Abminderungsfaktor nach EN 1992-4:2018 für verfüllten Ringspalt	α_{gap} [-]	0,5			
Herausziehen					
Charakteristischer Widerstand in gerissenem Beton	$N_{Rk,p,C2}$ [kN]	11,7	20,1	25,8	25,8
Betonausbruch					
Effective embedment depth	$h_{ef}^{2)}$ [mm]	66,1	87,3	104,3	104,3
Beton- ausbruch	Randabstand	$c_{cr,N}$ [mm]	1,5 h_{ef}		
	Achsabstand	$s_{cr,N}$ [mm]	3 h_{ef}		
Montagebeiwert	γ_{inst} [-]	1,0			
Betonausbruch auf der lastabgewandten Seite (pry-out)					
Pry-out Faktor	k_8 [-]	2,0			
Betonkantenbruch					
Wirksame Dübellänge	l_f [mm]	85	110	130	130
Wirksamer Außendurchmesser	d_{nom} [mm]	16			

¹⁾ Sofern andere nationale Regelungen fehlen.

²⁾ Wenn $h_{nom} > h_{nom1}$ und $< h_{nom3}$ kann das aktuelle h_{ef} für Betonausbruch nach den Tabellen A5 oder A8 gerechnet werden

Hilti Betonschraube HUS4

Leistungen

Wesentliche Merkmale für die seismische Einwirkung C2 in Beton

Anhang C14

**Tabelle C12: Wesentliche Merkmale unter Brandbeanspruchung in Beton für
HUS4 (T)-H Kohlenstoffstahl Größe 8 und 10**

Größe HUS4 (T)-H(F)			8			T-8			10			
			h_{nom1}	h_{nom2}	h_{nom3}	h_{nom1}	h_{nom2}	h_{nom3}	h_{nom1}	h_{nom2}	h_{nom3}	
Länge des Dübels im Beton	h_{nom}	[mm]	40	60	70	50	60	70	55	75	85	
Adjustierung												
Max. Dicke der Unterfütterung	t_{adj}	[mm]	-	10	10	-	10	10	-	10	10	
Max. Anzahl der Adjustierungen	n_a	[-]	-	2	2	-	2	2	-	2	2	
Stahlversagen unter Zug und Querbeanspruchung ($F_{RK,s,fi} = N_{RK,s,fi} = V_{RK,s,fi}$)												
Charakteristischer Widerstand	R30	$F_{RK,s,fi}$	[kN]	2,6		3,2	3,5	3,8	4,1	4,2		
	R60	$F_{RK,s,fi}$	[kN]	1,9		2,4	2,6	2,8	3,1	3,1		
	R90	$F_{RK,s,fi}$	[kN]	1,2		1,6	1,6	1,9	2,2	2,3		
	R120	$F_{RK,s,fi}$	[kN]	0,9		1,2	1,2	1,5	1,5	1,7		
	R30	$M^0_{RK,s,fi}$	[Nm]	2,3		3,8	4,1	4,4	4,8	4,9		
	R60	$M^0_{RK,s,fi}$	[Nm]	1,7		2,8	3,0	3,4	3,6	3,7		
	R90	$M^0_{RK,s,fi}$	[Nm]	1,1		1,9	1,9	2,3	2,6	2,7		
	R120	$M^0_{RK,s,fi}$	[Nm]	0,8		1,5	1,4	1,7	1,8	1,9		
Herausziehen												
Charakteristischer Widerstand	R30	$N^0_{RK,p,fi}$	[kN]	1,3	2,8	3,6	1,5	2,3	3,0	2,3	3,9	4,7
	R60											
	R90											
	R120	$N^0_{RK,p,fi}$	[kN]	1,0	2,2	2,8	1,2	1,8	2,4	1,9	3,1	3,7
Betonausbruch												
Charakteristischer Widerstand	R30	$N^0_{RK,c,fi}$	[kN]	0,8	2,6	4,0	1,8	2,6	4,0	2,0	4,7	6,5
	R60											
	R90											
	R120	$N^0_{RK,c,fi}$	[kN]	0,7	2,1	3,2	1,4	2,1	3,2	1,6	3,7	5,2
Randabstand												
R30 bis R120	$C_{cr,fi}$	[mm]	2 h_{ef}									
Der Randabstand muss ≥ 300 mm betragen, wenn die Brandbeanspruchung von mehr als einer Seite angreift.												
Achsabstand												
R30 bis R120	$S_{cr,fi}$	[mm]	2 $C_{cr,fi}$									
Betonausbruch auf der lastabgewandten Seite (pry-out)												
R30 bis R120	k_8	[-]	1,0	2,0	1,0	2,0	1,0	2,0	1,0	2,0		
Bei feuchtem Beton ist die Verankerungstiefe um mindestens 30 mm zu vergrößern.												

Hilti Betonschraube HUS4

Leistungen
Wesentliche Merkmale unter Brandbeanspruchung in Beton

Anhang C15

Tabelle C13: Wesentliche Merkmale unter Brandbeanspruchung in Beton für HUS4 (T)-H Kohlenstoffstahl Größe 10 bis 14

Größe HUS4 (T)-H(F)			T-10			12			14					
			h_{nom1}	h_{nom2}	h_{nom3}	h_{nom1}	h_{nom2}	h_{nom3}	h_{nom1}	h_{nom2}	h_{nom3}			
Länge des Dübels im Beton	h_{nom}	[mm]	55	75	85	60	80	100	65	85	115			
Adjustierung														
Max. Dicke der Unterfütterung	t_{adj}	[mm]	-	10	10	10	10	10	10	10	10			
Max. Anzahl der Adjustierungen	n_a	[-]	-	2	2	2	2	2	2	2	2			
Stahlversagen unter Zug und Querbeanspruchung ($F_{Rk,s,fi} = N_{Rk,s,fi} = V_{Rk,s,fi}$)														
Charakteristischer Widerstand	R30	$F_{Rk,s,fi}$	[kN]	6,1	6,2	7,5	7,6	7,6	10,3	10,4	10,5			
	R60	$F_{Rk,s,fi}$	[kN]	4,6	4,7	5,5	5,7	5,8	7,7	7,9	8,0			
	R90	$F_{Rk,s,fi}$	[kN]	3,1	3,2	3,7	3,9	4,1	5,2	5,6	5,8			
	R120	$F_{Rk,s,fi}$	[kN]	2,4	2,5	2,8	3,0	3,1	3,9	4,2	4,4			
	R30	$M^0_{Rk,s,fi}$	[Nm]	9,1	9,2	11,4	11,6	11,6	18,9	19,2	19,3			
	R60	$M^0_{Rk,s,fi}$	[Nm]	6,9	7,0	8,4	8,8	8,9	14,1	14,6	14,8			
	R90	$M^0_{Rk,s,fi}$	[Nm]	4,6	4,8	5,7	6,0	6,2	9,5	10,2	10,7			
	R120	$M^0_{Rk,s,fi}$	[Nm]	3,5	3,7	4,3	4,6	4,7	7,2	7,7	8,1			
Herausziehen														
Charakteristischer Widerstand	R30	$N^0_{Rk,p,fi}$	[kN]	2,4	4,0	4,9	2,6	4,2	6,1	2,9	4,5	7,5		
	R60			R90	[kN]	1,9	3,2	3,9	2,1	3,4	4,9	2,3	3,6	6,0
	R120													
Betonausbruch														
Charakteristischer Widerstand	R30	$N^0_{Rk,c,fi}$	[kN]	2,0	4,7	6,6	2,4	5,4	9,8	2,9	6,1	13,9		
	R60			R90	[kN]	1,6	3,8	5,3	1,9	4,3	7,8	2,3	4,9	11,1
	R120													
Randabstand														
R30 bis R120	$C_{cr,fi}$	[mm]	2 h_{ef}											
Der Randabstand muss ≥ 300 mm betragen, wenn die Brandbeanspruchung von mehr als einer Seite angreift.														
Achsabstand														
R30 bis R120	$S_{cr,fi}$	[mm]	2 $C_{cr,fi}$											
Betonausbruch auf der lastabgewandten Seite (pry-out)														
R30 bis R120	k_8	[-]	1,0	2,0	2,0									
Bei feuchtem Beton ist die Verankerungstiefe um mindestens 30 mm zu vergrößern.														

Hilti Betonschraube HUS4

Leistungen
Wesentliche Merkmale unter Brandbeanspruchung in Beton

Anhang C16

Tabelle C14: Wesentliche Merkmale unter Brandbeanspruchung in Beton für HUS4-H Kohlenstoffstahl Größe 16

Größe HUS4			H(F) 16		H(F) 16 G02			DW 16	
			h_{nom1}	h_{nom2}	h_{nom1}	h_{nom2}	h_{nom3}	h_{nom3}	
Länge des Dübels im Beton	h_{nom}	[mm]	85	130	85	110	130	130	
Adjustierung									
Max. Dicke der Unterfütterung	t_{adj}	[mm]	-	-	10	10	10	10	
Max. Anzahl der Adjustierungen	n_a	[-]	-	-	2	2	2	2	
Stahlversagen unter Zug und Querbeanspruchung ($F_{Rk,s,fi} = N_{Rk,s,fi} = V_{Rk,s,fi}$)									
Characteristic resistance	R30	$F_{Rk,s,fi}$	[kN]	10,6	10,7	10,6	10,6	10,7	3,9
	R60	$F_{Rk,s,fi}$	[kN]	8,1	8,2	8,1	8,1	8,2	2,9
	R90	$F_{Rk,s,fi}$	[kN]	5,7	5,9	5,7	5,7	5,9	2,5
	R120	$F_{Rk,s,fi}$	[kN]	4,3	4,5	4,3	4,3	4,5	2,0
	R30	$M^0_{Rk,s,fi}$	[Nm]	23,7	23,9	23,7	23,7	23,9	9,2
	R60	$M^0_{Rk,s,fi}$	[Nm]	18,1	18,3	18,1	18,1	18,3	6,9
	R90	$M^0_{Rk,s,fi}$	[Nm]	12,7	13,2	12,7	12,7	13,2	6,0
	R120	$M^0_{Rk,s,fi}$	[Nm]	9,6	10,0	9,6	9,6	10,0	4,6
Herausziehen									
Charakteristischer Widerstand	R30	$N^0_{Rk,p,fi}$	[kN]	4,6	8,7	5,1	9,1	11,7	11,7
	R60			4,6	8,7	5,1	9,1	11,7	11,7
	R90			4,6	8,7	5,1	9,1	11,7	11,7
	R120	$N^0_{Rk,p,fi}$	[kN]	3,7	7,0	4,1	7,3	9,4	9,4
Betonausbruch									
Charakteristischer Widerstand	R30	$N^0_{Rk,c,fi}$	[kN]	6,2	19,4	6,1	12,3	19,1	19,1
	R60			6,2	19,4	6,1	12,3	19,1	19,1
	R90			6,2	19,4	6,1	12,3	19,1	19,1
	R120	$N^0_{Rk,c,fi}$	[kN]	4,9	15,5	4,9	9,8	15,3	15,3
Randabstand									
R30 bis R120	$c_{cr,fi}$	[mm]	2 h_{ef}						
Der Randabstand muss ≥ 300 mm betragen, wenn die Brandbeanspruchung von mehr als einer Seite angreift.									
Achsabstand									
R30 bis R120	$s_{cr,fi}$	[mm]	2 $c_{cr,fi}$						
Betonausbruch auf der lastabgewandten Seite (pry-out)									
R30 bis R120	k_8	[-]	2,0						
Bei feuchtem Beton ist die Verankerungstiefe um mindestens 30 mm zu vergrößern.									

Hilti Betonschraube HUS4

Leistungen
Wesentliche Merkmale unter Brandbeanspruchung in Beton

Anhang C17

Tabelle C15: Wesentliche Merkmale unter Brandbeanspruchung in Beton für HUS4 (T)-C Kohlenstoffstahl Größe 8

Größe HUS4 (T)-C				8			T-8			
				h_{nom1}	h_{nom2}	h_{nom3}	h_{nom1}	h_{nom2}	h_{nom3}	
Länge des Dübels im Beton	h_{nom}	[mm]		40	60	70	50	60	70	
Adjustierung										
Max. Dicke der Unterfütterung	t_{adj}	[mm]		-	10	10	-	10	10	
Max. Anzahl der Adjustierungen	n_a	[-]		-	2	2	-	2	2	
Stahlversagen unter Zug und Querbeanspruchung ($F_{Rk,s,fi} = N_{Rk,s,fi} = V_{Rk,s,fi}$)										
Charakteristischer Widerstand	R30	$F_{Rk,s,fi}$	[kN]		0,5			0,5		
	R60	$F_{Rk,s,fi}$	[kN]		0,4			0,4		
	R90	$F_{Rk,s,fi}$	[kN]		0,3			0,3		
	R120	$F_{Rk,s,fi}$	[kN]		0,2			0,2		
	R30	$M^0_{Rk,s,fi}$	[Nm]		0,4			0,6		
	R60	$M^0_{Rk,s,fi}$	[Nm]		0,3			0,5		
	R90	$M^0_{Rk,s,fi}$	[Nm]		0,2			0,4		
	R120	$M^0_{Rk,s,fi}$	[Nm]		0,2			0,3		
Herausziehen										
Charakteristischer Widerstand	R30	$N^0_{Rk,p,fi}$	[kN]							
	R60			1,3	2,8	3,6	1,5	2,3	3,0	
	R90									
	R120	$N^0_{Rk,p,fi}$	[kN]	1,0	2,2	2,8	1,2	1,8	2,4	
Betonausbruch										
Charakteristischer Widerstand	R30	$N^0_{Rk,c,fi}$	[kN]							
	R60			0,8	2,6	4,0	1,8	2,6	4,0	
	R90									
	R120	$N^0_{Rk,c,fi}$	[kN]	0,7	2,1	3,2	1,5	2,1	3,2	
Randabstand										
R30 bis R120	$C_{cr,fi}$	[mm]		2 h_{ef}						
Der Randabstand muss ≥ 300 mm betragen, wenn die Brandbeanspruchung von mehr als einer Seite angreift.										
Achsabstand										
R30 bis R120	$S_{cr,fi}$	[mm]		2 $C_{cr,fi}$						
Betonausbruch auf der lastabgewandten Seite (pry-out)										
R30 bis R120	k_8	[-]		1,0	2,0		1,0	2,0		
Bei feuchtem Beton ist die Verankerungstiefe um mindestens 30 mm zu vergrößern.										

Hilti Betonschraube HUS4

Leistungen
Wesentliche Merkmale unter Brandbeanspruchung in Beton

Anhang C18

Tabelle C16: Wesentliche Merkmale unter Brandbeanspruchung in Beton für HUS4 (T)-C Kohlenstoffstahl Größe 10

Größe HUS4-C				10			T-10			
				h_{nom1}	h_{nom2}	h_{nom3}	h_{nom1}	h_{nom2}	h_{nom3}	
Länge des Dübels im Beton	h_{nom}	[mm]		55	75	85	55	75	85	
Adjustierung										
Max. Dicke der Unterfütterung	t_{adj}	[mm]		-	10	10	-	10	10	
Max. Anzahl der Adjustierungen	n_a	[-]		-	2	2	-	2	2	
Stahlversagen unter Zug und Querbeanspruchung ($F_{RK,s,fi} = N_{RK,s,fi} = V_{RK,s,fi}$)										
Charakteristischer Widerstand	R30	$F_{RK,s,fi}$	[kN]		1,0			1,2		
	R60	$F_{RK,s,fi}$	[kN]		0,9			1,0		
	R90	$F_{RK,s,fi}$	[kN]		0,7			0,8		
	R120	$F_{RK,s,fi}$	[kN]		0,6			0,6		
	R30	$M^0_{RK,s,fi}$	[Nm]		1,2			1,7		
	R60	$M^0_{RK,s,fi}$	[Nm]		1,0			1,5		
	R90	$M^0_{RK,s,fi}$	[Nm]		0,8			1,1		
	R120	$M^0_{RK,s,fi}$	[Nm]		0,6			0,9		
Herausziehen										
Charakteristischer Widerstand	R30	$N^0_{RK,p,fi}$	[kN]							
	R60			2,3	3,9	4,7	2,4	4,0	5,0	
	R90									
	R120	$N^0_{RK,p,fi}$	[kN]	1,9	3,1	3,7	1,9	3,2	4,0	
Betonausbruch										
Charakteristischer Widerstand	R30	$N^0_{RK,c,fi}$	[kN]							
	R60			2,0	4,7	6,5	2,0	4,7	6,6	
	R90									
	R120	$N^0_{RK,c,fi}$	[kN]	1,6	3,7	5,2	1,6	3,8	5,3	
Randabstand										
R30 bis R120	$C_{cr,fi}$	[mm]		2 h_{ef}						
Der Randabstand muss ≥ 300 mm betragen, wenn die Brandbeanspruchung von mehr als einer Seite angreift.										
Achsabstand										
R30 bis R120	$S_{cr,fi}$	[mm]		2 $C_{cr,fi}$						
Betonausbruch auf der lastabgewandten Seite (pry-out)										
R30 bis R120	k_8	[-]		1,0	2,0	1,0	2,0			
Bei feuchtem Beton ist die Verankerungstiefe um mindestens 30 mm zu vergrößern.										

Hilti Betonschraube HUS4

Leistungen
Wesentliche Merkmale unter Brandbeanspruchung in Beton

Anhang C19

Tabelle C17: Wesentliche Merkmale unter Brandbeanspruchung in Beton für HUS4-A Kohlenstoffstahl

Größe HUS4-A(F)			10			14		
			h_{nom1}	h_{nom2}	h_{nom3}	h_{nom1}	h_{nom2}	h_{nom3}
Länge des Dübels im Beton	h_{nom}	[mm]	55	75	85	65	85	115
Adjustierung								
Max. Dicke der Unterfütterung	t_{adj}	[mm]	-	10	10	10	10	10
Max. Anzahl der Adjustierungen	n_a	[-]	-	2	2	2	2	2
Stahlversagen unter Zug und Querbeanspruchung ($F_{RK,s,fi} = N_{RK,s,fi} = V_{RK,s,fi}$)								
Charakteristischer Widerstand	R30	$F_{RK,s,fi}$ [kN]	4,2			8,4		
	R60	$F_{RK,s,fi}$ [kN]	3,3			6,8		
	R90	$F_{RK,s,fi}$ [kN]	2,5			5,1		
	R120	$F_{RK,s,fi}$ [kN]	2,1			4,3		
	R30	$M^0_{RK,s,fi}$ [Nm]	4,8			15,4		
	R60	$M^0_{RK,s,fi}$ [Nm]	3,8			12,4		
	R90	$M^0_{RK,s,fi}$ [Nm]	2,9			9,3		
	R120	$M^0_{RK,s,fi}$ [Nm]	2,4			7,8		
Herausziehen								
Charakteristischer Widerstand	R30	$N^0_{RK,p,fi}$ [kN]	2,3	3,9	4,7	2,9	4,5	7,5
	R60							
	R90							
	R120	$N^0_{RK,p,fi}$ [kN]	1,9	3,1	3,7	2,3	3,6	6,0
Betonausbruch								
Charakteristischer Widerstand	R30	$N^0_{RK,c,fi}$ [kN]	2,0	4,7	6,5	2,9	6,1	13,9
	R60							
	R90							
	R120	$N^0_{RK,c,fi}$ [kN]	1,6	3,7	5,2	2,3	4,9	11,1
Randabstand								
R30 bis R120	$c_{Cr,fi}$	[mm]	2 h_{ef}					
Der Randabstand muss ≥ 300 mm betragen, wenn die Brandbeanspruchung von mehr als einer Seite angreift.								
Achsabstand								
R30 bis R120	$s_{Cr,fi}$	[mm]	2 $c_{Cr,fi}$					
Betonausbruch auf der lastabgewandten Seite (pry-out)								
R30 bis R120	k_8	[-]	1,0	2,0				
Bei feuchtem Beton ist die Verankerungstiefe um mindestens 30 mm zu vergrößern.								

Hilti Betonschraube HUS4

Leistungen
Wesentliche Merkmale unter Brandbeanspruchung in Beton

Anhang C20

Tabelle C18: Wesentliche Merkmale unter Brandbeanspruchung in Beton für HUS4 nichtrostender Stahl

Größe HUS4			6		8				10				14		
Typ			HR	CR	HR		CR		HR		CR		HR		
Länge des Dübels im Beton	h_{nom}	[mm]	55		60	80	60	80	70	90	70	90	70	110	
Stahlversagen unter Zug und Querbeanspruchung ($F_{Rk,s,fi} = N_{Rk,s,fi} = V_{Rk,s,fi}$)															
Charakteristischer Widerstand	R30	$F_{Rk,s,fi}$	[kN]	4,9	0,2	9,3	0,8	18,5	1,4	41,7					
	R60	$F_{Rk,s,fi}$	[kN]	3,3	0,2	6,3	0,6	12,0	1,1	26,9					
	R90	$F_{Rk,s,fi}$	[kN]	1,8	0,2	3,2	0,5	5,4	0,9	12,2					
	R120	$F_{Rk,s,fi}$	[kN]	1,0	0,1	1,7	0,4	2,4	0,8	5,4					
	R30	$M^0_{Rk,s,fi}$	[Nm]	4,0	0,2	8,2	0,8	19,4	1,5	65,6					
	R60	$M^0_{Rk,s,fi}$	[Nm]	2,7	0,2	5,5	0,7	12,6	1,2	42,4					
	R90	$M^0_{Rk,s,fi}$	[Nm]	1,4	0,1	2,8	0,5	5,7	0,9	19,2					
	R120	$M^0_{Rk,s,fi}$	[Nm]	0,8	0,1	1,5	0,4	2,5	0,8	8,5					
Herausziehen															
Charakteristischer Widerstand	R30	$N_{Rk,p,fi}$	[kN]	1,3		1,5	3,0	1,5	3,0	2,3	4,0	2,3	4,0	3,0	6,3
	R60			1,0		1,2	2,4	1,2	2,4	1,8	3,2	1,8	3,2	2,4	5,0
Randabstand															
R30 bis R120	$c_{cr,fi}$	[mm]	2 h_{ef}												
Achsabstand															
R30 bis R120	$s_{cr,fi}$	[mm]	2 $c_{cr,fi}$												
Betonausbruch auf der lastabgewandten Seite (pry-out)															
R30 bis R120	k_8	[-]	1,5				2,0								

Hilti Betonschraube HUS4

Leistungen
Wesentliche Merkmale unter Brandbeanspruchung in Beton

Anhang C21

Tabelle C19: Verschiebungen unter Zuglast für HUS4 Kohlenstoffstahl

Größe HUS4				8			8			10		
Typ				H(F), C			T-H(F), T-C			H(F), C, A(F)		
				h _{nom1}	h _{nom2}	h _{nom3}	h _{nom1}	h _{nom2}	h _{nom3}	h _{nom1}	h _{nom2}	h _{nom3}
Länge des Dübels im Beton		h _{nom}	[mm]	40	60	70	50	60	70	55	75	85
Gerissener Beton C20/25 bis C50/60	Zuglast	N	[kN]	2,6	5,4	6,9	4,3	5,7	7,6	3,8	7,5	8,6
		Verschiebung	δ _{N0}	[mm]	0,1	0,3	0,4	0,3	0,4	0,3	0,2	0,4
	δ _{N∞}		[mm]	0,3	0,4	0,4	0,7	0,7	0,6	0,7	0,7	0,9
Ungerissener Beton C20/25 bis C50/60	Zuglast	N	[kN]	3,7	7,1	9,1	6,6	8,9	11,8	5,2	10,5	12,2
		Verschiebung	δ _{N0}	[mm]	0,1	0,2	0,2	0,1	0,2	0,1	0,1	0,3
	δ _{N∞}		[mm]	0,3	0,4	0,4	0,3	0,3	0,3	0,7	0,7	0,9

Größe HUS4				10			12			14		
Typ				T-H(F), T-C			H			H(F), A(F)		
				h _{nom1}	h _{nom2}	h _{nom3}	h _{nom1}	h _{nom2}	h _{nom3}	h _{nom1}	h _{nom2}	h _{nom3}
Länge des Dübels im Beton		h _{nom}	[mm]	55	75	85	60	80	100	65	85	115
Gerissener Beton C20/25 bis C50/60	Zuglast	N	[kN]	5,7	9,5	13,2	5,1	8,2	11,7	5,7	8,6	14,4
		Verschiebung	δ _{N0}	[mm]	0,4	0,4	0,4	0,3	0,4	0,6	0,3	0,4
	δ _{N∞}		[mm]	0,4	0,4	0,5	0,9	0,9	1,2	1,3	1,3	1,5
Ungerissener Beton C20/25 bis C50/60	Zuglast	N	[kN]	8,7	14,8	20,5	6,8	10,8	15,5	7,5	11,7	19,1
		Verschiebung	δ _{N0}	[mm]	0,1	0,1	0,1	0,2	0,3	0,4	0,2	0,3
	δ _{N∞}		[mm]	0,2	0,2	0,2	0,9	0,9	1,2	1,3	1,3	1,5

Größe HUS4				16		16			16
Typ				H(F)		H(F) G02			DW
				h _{nom1}	h _{nom2}	h _{nom1}	h _{nom2}	h _{nom3}	h _{nom}
Länge des Dübels im Beton		h _{nom}	[mm]	85	130	85	110	130	130
Gerissener Beton C20/25 bis C50/60	Zuglast	N	[kN]	8,7	16,7	8,8	13,4	17,5	17,5
		Verschiebung	δ _{N0}	[mm]	0,1	0,4	0,14	0,17	0,18
	δ _{N∞}		[mm]	1,3	1,4	0,88	1,07	1,11	1,11
Ungerissener Beton C20/25 bis C50/60	Zuglast	N	[kN]	11,5	22,9	12,6	19,1	25,0	25,0
		Verschiebung	δ _{N0}	[mm]	0,4	0,3	0,12	0,14	0,15
	δ _{N∞}		[mm]	1,3	1,4	0,56	0,56	0,56	0,56

Hilti Betonschraube HUS4

Leistungen
Verschiebungen für statische und quasi-statische Lasten

Anhang C22

Tabelle C20: Verschiebungen unter Zuglast für HUS4 nichtrostender Stahl

Größe HUS4				6		8		10		14		
Typ				HR, CR		HR, CR		HR, CR		H		
Länge des Dübels im Beton	h_{nom}	[mm]		55	60	80	70	90	70	85	70	110
Gerissener Beton C20/25 bis C50/60	Zuglast	N	[kN]	1,7	2,4	4,8	3,6	6,3	3,0	4,1	4,8	9,9
		δ_{N0}	[mm]	0,4	0,5	0,7	0,3	0,6	0,2	0,3	0,9	1,4
	Verschiebung	$\delta_{N\infty}$	[mm]	0,5	0,7	1,1	0,6	1,1	0,3	0,7	1,1	1,4
		$\delta_{N,seis}$	[mm]	1)	1)	1,2	1)	1,2	1)	1,2	1)	0,4
Ungerissener Beton C20/25 bis C50/60	Zuglast	N	[kN]	3,1	4,8	6,3	6,3	9,9	4,8	6,8	7,5	16,0
		δ_{N0}	[mm]	0,8	0,7	1,6	0,3	1,3	0,2	0,3	0,7	1,0
	Verschiebung	$\delta_{N\infty}$	[mm]	0,8	0,7	1,6	0,3	1,3	0,3	0,7	0,7	1,0

1) Keine Leistung bewertet.

Hilti Betonschraube HUS4

Leistungen
Verschiebungen für statische und quasi-statische Lasten

Anhang C23

Tabelle C21: Verschiebungen unter Querlast für HUS4 Kohlenstoffstahl

Größe HUS4				8			8			10		
Typ				H(F), C			T-H(F), T-C			H(F), C, A(F)		
				h_{nom1}	h_{nom2}	h_{nom3}	h_{nom1}	h_{nom2}	h_{nom3}	h_{nom1}	h_{nom2}	h_{nom3}
Länge des Dübels im Beton		h_{nom}	[mm]	40	60	70	40	60	70	55	75	85
Beton C20/25 bis C50/60	Querlast	V	[kN]	10,7	10,7	12,5	8,1	8,1	8,1	16,5	16,5	18,3
		Verschiebung	δ_{V0}	[mm]	1,3	1,1	0,9	2,5	3,4	2,9	1,4	1,3
	$\delta_{V\infty}$		[mm]	2,0	1,7	1,4	3,7	5,1	4,4	2,1	2,0	1,5

Größe HUS4				10			12			14		
Typ				T-H(F), T-C			H(F)			H(F), A(F)		
				h_{nom1}	h_{nom2}	h_{nom3}	h_{nom1}	h_{nom2}	h_{nom3}	h_{nom1}	h_{nom2}	h_{nom3}
Länge des Dübels im Beton		h_{nom}	[mm]	55	75	85	60	80	100	65	85	115
Beton C20/25 bis C50/60	Querlast	V	[kN]	13,3			22,2	22,2	25,7	31,4	35,4	35,4
		Verschiebung	δ_{V0}	[mm]	3,8	3,7	3,2	1,6	1,6	0,9	5,3	5,3
	$\delta_{V\infty}$		[mm]	5,7	5,5	4,9	2,3	2,4	1,4	7,9	7,9	6,0

Größe HUS4				16		16			16
Typ				H(F)		H(F) G02			DW
				h_{nom1}	h_{nom2}	h_{nom1}	h_{nom2}	h_{nom3}	h_{nom}
Länge des Dübels im Beton		h_{nom}	[mm]	85	130	85	110	130	130
Concrete C20/25 to C50/60	Shear Load	V	[kN]	37,2	41,8	44,5	44,5	44,5	44,5
		Displacement	δ_{V0}	[mm]	2,3	1,8	3,5	3,5	3,5
	$\delta_{V\infty}$		[mm]	3,5	2,7	5,3	5,3	5,3	5,3

Tabelle C22: Verschiebungen unter Querlast für HUS4 nichtrostender Stahl

Fastener size HUS				6	8		10		14	
Typ				HR, CR	HR, CR		HR, CR		HR	
				h_{nom}	h_{nom}	h_{nom}	h_{nom}	h_{nom}	h_{nom}	h_{nom}
Länge des Dübels im Beton		h_{nom}	[mm]	55	60	80	70	90	70	110
Beton C20/25 bis C50/60	Querlast	V	[kN]	7,8	11,0	12,4	13,6	15,7	12,9	27,3
		Verschiebung	δ_{V0}	[mm]	0,4	2,0	2,3	1,1	1,7	3,5
	$\delta_{V\infty}$		[mm]	0,5	2,4	2,9	1,5	2,4	3,9	4,3
	$\delta_{V,C1}$		[mm]	1)	1)	4,8	1)	5,3	1)	7,6

1) Keine Leistung bewertet.

Hilti Betonschraube HUS4

Leistungen
Verschiebungen für statische und quasi-statische Lasten

Anhang C24

Tabelle C23: Verschiebungen unter Zug- und Querbeanspruchung für seismische Leistungskategorie C2 für HUS4 Kohlenstoffstahl

Größe HUS4 Typ			8		8			10		
			H(F), C		T-H(F), T-C			H(F), C, A(F)		
			h_{nom2}	h_{nom3}	h_{nom1}	h_{nom2}	h_{nom3}	h_{nom1}	h_{nom2}	h_{nom3}
Länge des Dübels im Beton	h_{nom}	[mm]	60	70	50	60	70	55	75	85
Zuglast										
Verschiebung DLS	$\delta_{N,C2 (DLS)}$	[mm]	0,59		0,35			0,80		
Verschiebung ULS	$\delta_{N,C2 (ULS)}$	[mm]	1,36		0,65			3,66		
Querlast mit Hilti Verfüll-Set (HUS4-H und HUS4-A)										
Verschiebung DLS	$\delta_{V,C2 (DLS)}$	[mm]	3,57	1,85	3,37	1,81	4,32	1,72		
Verschiebung ULS	$\delta_{V,C2 (ULS)}$	[mm]	5,56	5,44	5,38	4,60	7,72	6,88		
Querlast ohne Hilti Verfüll-Set										
Verschiebung DLS	$\delta_{V,C2 (DLS)}$	[mm]	3,57	4,64	3,37	3,93	4,32	5,02		
Verschiebung ULS	$\delta_{V,C2 (ULS)}$	[mm]	5,56	7,96	5,38	5,55	7,72	8,97		

Größe HUS4 Typ			10			12			14		
			T-H(F), T-C			H(F)			H(F), A(F)		
			h_{nom1}	h_{nom2}	h_{nom3}	h_{nom1}	h_{nom2}	h_{nom3}	h_{nom1}	h_{nom2}	h_{nom3}
Nominal embedment depth	h_{nom}	[mm]	55	75	85	60	80	100	65	85	115
Zuglast											
Verschiebung DLS	$\delta_{N,C2 (DLS)}$	[mm]	0,57			0,77			1,06		
Verschiebung ULS	$\delta_{N,C2 (ULS)}$	[mm]	2,08			2,78			3,89		
Querlast mit Hilti Verfüll-Set (HUS4-H und HUS4-A)											
Verschiebung DLS	$\delta_{V,C2 (DLS)}$	[mm]	4,07	1,80	4,05	1,73	4,00	2,52			
Verschiebung ULS	$\delta_{V,C2 (ULS)}$	[mm]	7,50	4,03	7,07	5,62	6,09	6,79			
Querlast ohne Hilti Verfüll-Set											
Verschiebung DLS	$\delta_{V,C2 (DLS)}$	[mm]	4,07	4,15	4,05	4,90	4,00	4,93			
Verschiebung ULS	$\delta_{V,C2 (ULS)}$	[mm]	7,50	6,15	7,07	7,00	6,09	9,14			

Hilti Betonschraube HUS4

Leistungen
Verschiebungen für seismische Leistungskategorie C2

Anhang C25

Table C23 fortgesetzt

Größe HUS4			16			16
Typ			H(F) G02			DW
			h_{nom1}	h_{nom2}	h_{nom3}	h_{nom}
Nominal embedment depth	h_{nom}	[mm]	85	110	130	130
Zuglast						
Verschiebung DLS	$\delta_{N,C2 (DLS)}$	[mm]	1,56		1,68	
Verschiebung ULS	$\delta_{N,C2 (ULS)}$	[mm]	4,64		4,69	
Querlast mit Hilti Verfüll-Set						
Verschiebung DLS	$\delta_{V,C2 (DLS)}$	[mm]			5,84	
Verschiebung ULS	$\delta_{V,C2 (ULS)}$	[mm]			11,04	
Querlast ohne Hilti Verfüll-Set						
Verschiebung DLS	$\delta_{V,C2 (DLS)}$	[mm]			5,84	
Verschiebung ULS	$\delta_{V,C2 (ULS)}$	[mm]			11,04	

Hilti Betonschraube HUS4

Performances
Displacement values in case of seismic C2 loading

Anhang C26